

Section I:

Conceptual and Technical Issues

Chapter 1

Reliability Theory of Aging and Longevity

Leonid A. Gavrilov and Natalia S. Gavrilova

I. Introduction

There is growing interest in scientific explanations of aging and in the search for a general theory that can explain what aging is and why and how it happens.

There is also a need for a general theoretical framework that would allow researchers to handle an enormous amount of diverse observations related to aging phenomena. Empirical observations on aging have become so abundant that a special four-volume encyclopedia, *The Encyclopedia of Aging* (1,591 pages), is now required for even partial coverage of the accumulated facts (Ekerdt, 2002). To transform these numerous and diverse observations into a comprehensive body of knowledge—a general theory of species aging and longevity—is required.

The prevailing research strategy now is to focus on the molecular level in the hopes of understanding the proverbial nuts and bolts of the aging process. In accordance with this approach, many aging theories explain the aging of organ-

isms through the aging of organism components. However, this circular reasoning of assuming aging in order to “explain” aging eventually leads to a logical dead end because when moving in succession from the aging of organisms to the aging of organs, tissues, and cells, we eventually come to atoms, which are known not to age. A situation with non-aging components exists not only at the level of atoms, but it may also be observed at higher levels of system organization when its components fail at random with a constant risk of failure independent on age. Even such complex biological structures as cells may sometimes demonstrate a non-aging behavior when their loss follows a simple law of radioactive decay (Burns *et al.*, 2002; Clarke *et al.*, 2000, 2001a,b; Heintz, 2000).

Thus, we come to the following basic question on the origin of aging: How can we explain the aging of a system built of non-aging elements?

This question invites us to start thinking about the possible systemic nature of

aging and to wonder whether aging may be a property of the system as a whole. In other words, perhaps we need to broaden our vision and be more concerned with the bigger picture of the aging phenomenon rather than its details.

To illustrate the need for a broad vision, consider the following questions:

- Would it be possible to understand a newspaper article by looking at it through an electronic microscope?
- Would the perception of a picture in an art gallery be deeper and more comprehensive at the shortest possible distance from it?

Evolutionary perspective on aging and longevity is one way to stay focused on the bigger picture (see recent reviews by Charlesworth, 2000; Gavrilova & Gavrilov, 2002; Martin, 2002; Partridge & Gems, 2002). Evolutionary explanations of aging and limited longevity of biological species are based on two major evolutionary theories: the mutation accumulation theory (Charlesworth, 2001; Medawar, 1946) and the antagonistic pleiotropy theory (Williams, 1957). These two theories can be briefly summarized as follows:

1. Mutation accumulation theory:

From the evolutionary perspective, aging is an inevitable result of the declining force of natural selection with age. For example, a mutant gene that kills young children will be strongly selected against (will not be passed to the next generation), whereas a lethal mutation that affects only people over the age of 80 will experience no selection because people with this mutation will have already passed it on to their offspring by that age. Over successive generations, late-acting deleterious mutations will accumulate, leading to an increase in mortality rates late in life.

2. Antagonistic pleiotropy theory:

Late-acting deleterious genes may even be favored by selection and be actively accumulated in populations if they have beneficial effects early in life.

Note that these two theories of aging are not mutually exclusive, and both evolutionary mechanisms may operate at the same time. The main difference between the two theories is that in the mutation accumulation theory, genes with negative effects at old age accumulate passively from one generation to the next, whereas in the antagonistic pleiotropy theory, these genes are actively kept in the gene pool by selection (Le Bourg, 2001). The actual relative contribution of each evolutionary mechanism to species aging has not yet been determined, and this scientific problem is the main focus of current research in evolutionary biology.

Evolutionary theories demonstrate that taking a step back from too-close consideration of the details over the “nuts and bolts” of the aging process helps us to gain a broader vision of the aging problem. The remaining question is whether the evolutionary perspective represents the ultimate general theoretical framework for explanations of aging. Or perhaps there may be even more general theories of aging, one step further removed from the particular details?

The main limitation of evolutionary theories of aging is that they are applicable only to systems that reproduce themselves, because these theories are based on the idea of natural selection and the notion of declining force of natural selection with age.

However, aging is a very general phenomenon—it is also observed in technical devices (such as cars), which do not reproduce themselves in a sexual or any other way and which are, therefore,

not subject to evolution through natural selection. For this simple reason, the evolutionary explanation of aging based on the idea of declining force of natural selection with age is not applicable to aging technical devices. Thus, there may be a more general explanation of aging, beyond mutation accumulation and antagonistic pleiotropy theories.

The quest for a general explanation of aging (age-related increase in failure rates), applicable both to technical devices and biological systems, invites us to consider the general theory of systems failure known as *reliability theory* (Barlow & Proschan, 1975; Barlow *et al.*, 1965; Gavrilov, 1978; Gavrilov & Gavrilova, 1991, 2001b, 2003b, 2004b,c; Gavrilov *et al.*, 1978).

Reliability theory was historically developed to describe the failure and aging of complex electronic (military) equipment, but the theory itself is a very general theory based on mathematics (probability theory) and a systems approach (Barlow & Proschan, 1975; Barlow *et al.*, 1965). The theory may therefore also be useful in describing and understanding the aging and failure of biological systems. It may be useful in several ways: first, by providing a kind of scientific language (definitions and cross-cutting principles), helping researchers create a logical framework for organizing numerous and diverse observations on aging into a coherent picture. Second, it helps researchers develop an intuition and understanding of the main principles of the aging process through consideration of simple mathematical models, having some features of a real world. Third, reliability theory is useful for generating and testing specific predictions, as well as deeper analyses of already collected data. The purpose of this chapter is to review some applications of reliability theory to the problem of biological aging.

II. General Overview of the Reliability Theory Approach

Reliability theory is a body of ideas, mathematical models, and methods aimed at predicting, estimating, understanding, and optimizing the life span and failure distributions of systems and their components (adapted from Barlow & Proschan, 1975). Reliability theory allows researchers to predict the age-related failure kinetics for a system of given architecture (reliability structure) and given reliability of its components.

A. Definition of Aging and Non-Aging Systems

A reliability-engineering approach to biological aging is appealing because it provides a common scientific language (general framework) for scientists working in different areas of aging research, helping to overcome disruptive specialization and allowing researchers to understand each other.

Specifically, reliability theory helps researchers define more clearly what *is* aging. In reliability theory, *aging* is defined as a phenomenon of *increasing risk of failure with the passage of time (age)*. If the risk of failure is not increasing with age (the “old is as good as new” principle), then there is no aging in terms of reliability theory, even if the calendar age of a system is increasing. For example, clocks that count time perfectly are not aging according to reliability theory (although they have a perfect “biomarker” for their continuous age changes—a displayed time and date). Thus, the regular and progressive changes over time *per se* do not constitute aging unless they produce some deleterious outcome (failures). In terms of reliability theory, the *dating problem* of determining the system *age* (time

elapsed since system creation) is different from the *performance assessment problem* of a system's *aging* (old becoming not as good as new). Perfect clocks having an ideal marker of their increasing age (time readings) are not aging, but progressively failing clocks are aging (although their "biomarkers" of age at the clock face may stop at a "forever young" date).

Moving to a biological example, we can say that the formation of regular seasonal tree rings tells us everything about tree age but little about tree aging. Moreover, a progressive disruption of the healthy formation of tree rings would indicate tree aging (although this disruption obscures the determination of tree age). In terms of reliability theory, the "biomarkers" of age used in forensics to estimate human ages may have nothing to do with human aging, no matter how accurate these "biomarkers" are in calendar age prediction. For example, an aspartate racemization in the teeth may be ideal for age estimation but not necessarily informative for predicting an increasing risk of death or other types of failure. On the other hand, loss of motor neurons with age would be highly relevant to the problem of human aging, no matter how poorly this loss is correlated with a person's age. These examples illustrate a fundamental difference between *biomarkers of age* (focused on the dating problem of accurate age determination) and *biomarkers of aging* (focused on the performance problem of system deterioration over time).

Thus, reliability theory helps to resolve a confusion that existed in biological aging research when some really important changes related to system deterioration over time were not properly discriminated from other neutral or benign changes closely correlated with calendar age. Reliability theory helps to clarify the difference between age (the passage of time) and aging (deterioration with age)—

concepts that are often confused with each other.¹

In terms of reliability theory, it is conceivable to imagine at least theoretically that some biological species may not demonstrate aging in certain conditions, although their age is always increasing. "Anti-aging" intervention, according to reliability theory, is not an oxymoron incompatible with the laws of Nature (reversing time), but rather refers to any feasible intervention that delays or prevents "the old becoming not as good as new." Later we will show that non-aging systems are common both in reliability theory and in the real physical world, so becoming old is not synonymous with aging.

B. Notion of System's Failure

The concept of failure is important to the analysis of a system's reliability. In reliability theory, failure is defined as the *event* when a required function is terminated (Rausand & Høyland, 2003). In other words, failure occurs when the system deviates from the optimistically anticipated and

¹The term *aging* is commonly used by biogerontologists and the public as a synonym to the word *senescence* (progressive deterioration with age). This interpretation of *aging* fits well with the reliability-theory approach, although the term *senescence* itself is not common in reliability theory. The problem with the term *senescence* is that it focuses too narrowly on old ages, when the senescent phenotypes become apparent (e.g., frailty). The term *aging* is more inclusive because it covers any age-related decline in performance, even if it starts early in life (e.g., an increase in human death rates after age 15). See also the second chapter of this book for a critique of other too-broad definitions of aging (Masoro, 2005). It remains to be seen whether the reliability-theory definition of aging will be universally accepted in the future or will be limited to its use in a specialized way as presented in this chapter.

desired behavior (it “fails”). Failures are often classified in two groups:

1. Degradation failures, where the system or component no longer functions properly, and

2. Catastrophic or fatal failures—the end of a system’s or a component’s life.

Examples of degradation failures in humans would be an onset of different types of health impairments, diseases, or disabilities, whereas catastrophic or fatal failures obviously correspond to death. The notions of aging and failure are related to each other in the following way: when the risk of failure outcomes increases with age (“old is not as good as new”), this is aging by definition. Note that according to reliability theory, aging is not just growing old; instead, aging is a degradation leading to failure (adverse health outcomes)—becoming sick, disabled, frail, and dead. Therefore, from a reliability-theory perspective, the notion of *healthy aging* is an oxymoron, like a healthy dying or a healthy disease. More appropriate terms instead of *healthy aging*, *successful aging*, or *aging well* would be *delayed aging*, *postponed aging*, *slow aging*, *arrested aging*, *negligible aging* (*senescence*), or, hopefully, *aging reversal*.

Because the reliability definition of biological aging is linked to health failures (adverse health outcomes, including death), aging without diseases is just as inconceivable as dying without death. Diseases and disabilities are an integral part (outcomes) of the aging process. Not every disease is related to aging, but every progression of disease with age has some relevance to aging: aging is a “maturation” of diseases with age. A more detailed discussion of the relationship between aging and diseases is provided in the second chapter of this book (Masoro, 2005).

Reliability theory also allows us to introduce more “physiological” definitions of failure that are not limited to such

failure outcomes as disease, disability, and death but describe a failure in performance tests for speed, strength, endurance, and so on. For example, it is possible to study the age dynamics of failure in sports competitions (marathon records, etc.), thereby making use of rich sports records for the purpose of scientific research on aging. Thus, reliability theory may be useful in studying “physiological” aging too.

Note that a system may have an aging behavior for one particular type of failure, but it may remain as good as new for some other type of failure. Thus, the notion of aging is outcome-specific—it requires specifying a particular type of failure (or group of failures) via which the system deteriorates.

Consequently, legitimate anti-aging interventions may be outcome-specific too, and limited to postponing some specific adverse health outcomes. *Aging* is likely to be a summary term for many different processes leading to various types of degradation failures, and each of these processes deserves to be studied and prevented.²

²One may wonder whether hip replacement surgery would qualify as an “anti-aging intervention” according to its description here. The answer to this question is not as simple as the question itself. It is conceivable that hip replacement therapy may prevent some patients from physical inactivity, stress, depression, loss of appetite, malnutrition, and drug overuse. The result may be that further progression of some diseases and disabilities could indeed slow down compared to patients who did not receive this treatment. In this case we can say that hip replacement therapy helps to oppose aging for some specific types of degradation failures in a particular group of patients (very limited anti-aging effect). It is true, however, that the term *anti-aging intervention* is usually associated with hopes for something far more radical, such as aging reversal in the future, applicable to all older people.

C. Basic Ideas and Formulas of Reliability Theory

Reliability of the system (or its component) refers to its ability to operate properly according to a specified standard (Crowder *et al.*, 1991). Reliability is described by the *reliability function* $S(x)$, which is the probability that a system (or component) will carry out its mission through time x (Rigdon & Basu, 2000). The reliability function (also called the *survival function*) evaluated at time x is just the probability, P , that the *failure time* X is beyond time x , $P(X > x)$. Thus, the reliability function is defined as follows:

$$\begin{aligned} S(x) &= P(X > x) = 1 - P(X \leq x) \\ &= 1 - F(x) \end{aligned}$$

where $F(x)$ is a standard *cumulative distribution function* in the probability theory (Feller, 1968). The best illustration for the reliability function $S(x)$ is a survival curve describing the proportion of those still alive by time x (the I_x column in life tables).

Failure rate, $\mu(x)$, or instantaneous risk of failure, also called the *hazard rate*, $h(x)$, or mortality force, is defined as the relative rate for reliability function decline:

$$\mu(x) = -\frac{dS_x}{S_x dx} = -\frac{d \ln S_x}{dx}$$

In those cases when the failure rate is constant (does not increase with age), we have a *non-aging system* (component) that does not deteriorate (does not fail more often) with age:

$$\mu(x) = k = \text{const}$$

The reliability function of non-aging systems (components) is described by the *exponential distribution*:

$$S(x) = S_0 e^{-kx}$$

This *failure law* describes “life span” distribution of atoms of radioactive elements and, therefore, is often called an *exponential decay law*. Interestingly, this failure law is observed in many wild populations with high extrinsic mortality (Finch, 1990; Gavrilov & Gavrilova, 1991). This kind of distribution is observed if failure (death) occurs entirely by chance, and it is also called a “one-hit model” or a “first order kinetics.” The non-aging behavior of a system can be detected graphically when the logarithm of the survival function decreases with age in a linear fashion.

Recent studies found that at least some cells in the aging organism might demonstrate a non-aging behavior.³ Specifically, the rate of neuronal death does not increase with age in a broad spectrum of aging-related neurodegenerative conditions (Heintz, 2000). These include 12 different models of photoreceptor degeneration, “excitotoxic” cell death *in vitro*, loss of cerebellar granule cells in a mouse model, and Parkinson’s and Huntington’s diseases (Clarke *et al.*, 2000). In this range of diseases, five different neuronal types are affected. In each of these cases, the rate of cell death is best fit by an exponential decay law with constant risk of death independent of age (death by chance only), arguing against models of progressive cell deterioration and aging (Clarke *et al.*, 2000, 2001a). An apparent lack of cell aging is also observed in the case of amyotrophic lateral sclerosis (ALS) (Clarke *et al.*, 2001a), retinitis pigmentosa (Burns *et al.*, 2002; Clarke *et al.*, 2000, 2001a; Massoff *et al.*, 1990), and idiopathic Parkinsonism (Calne, 1994; Clarke *et al.*, 2001b; Schulzer *et al.*, 1994).

³Non-aging behavior of cells should not be confused with cells’ immortality or their ability to self-replicate indefinitely. Instead non-aging behavior means that the risk of cell death (or loss of function) does not depend on cell age.

These observations correspond well with another observation that “an impressive range of cell functions in most organs remain unimpaired throughout the life span” (Finch, 1990, p. 425). These unimpaired functions might reflect the “no-aging” property known as “old as good as new” in survival analysis (Klein & Moerschberger, 1997, p. 38). Thus, we come again to the following fundamental question about the origin of aging: how can we explain the aging of a system built of non-aging elements? This question invites us to think about the possible systemic nature of aging and to wonder whether aging may be a property of the system as a whole. We would again like to emphasize the importance of looking at the bigger picture of the aging phenomenon in addition to its details, and we will suggest a possible answer to the posed question later in this chapter.

If failure rate increases with age, we have an *aging system* (component) that deteriorates (fails more often) with age. There are many failure laws for aging systems, and the most famous one in biology is the *Gompertz law* with exponential increase of the failure rates with age, which is observed for many biological species including humans (Finch, 1990; Gavrilov & Gavrilova, 1991; Gompertz, 1825; Makeham, 1860; Strehler, 1978):

$$\mu(x) = Re^{\alpha x}$$

where x is age, while R and α are positive parameters.

We will show later that there are some exceptions to the Gompertz law and that it is usually applicable within some age windows rather than the entire range of all possible ages.

According to the Gompertz law, the logarithm of failure rates increases linearly with age. This is often used in order to illustrate graphically the validity of the Gompertz law—the data are plotted in the semi-log scale (known as the Gompertz

plot) to check whether the logarithm of the failure rate is indeed increasing with age in a linear fashion.

For technical systems, one of the most popular models for the failure rate of aging systems is the Weibull model, the power-function increase in failure rates with age x (Weibull, 1939):

$$\mu(x) = ax^b$$

for $x \geq 0$, where $a, b > 0$

This law was suggested by Swedish engineer and mathematician Waloddi Weibull in 1939 to describe the strength of materials (Weibull, 1939). It is widely used to describe the aging and failure of technical devices (Barlow & Proschan, 1975; Rigdon & Basu, 2000; Weibull, 1951). According to the Weibull law, the logarithm of failure rate increases linearly with the *logarithm* of age, with a slope coefficient equal to parameter b . This is often used in order to illustrate graphically the validity of the Weibull law: the data are plotted in the log-log scale (known as the Weibull plot) to check whether the logarithm of the failure rate is indeed increasing with the *logarithm* of age in a linear fashion.

Both the Gompertz and the Weibull failure laws have their fundamental explanation rooted in reliability theory (Barlow & Proschan, 1975) and are the only two theoretically possible *limiting extreme value distributions* for systems whose life spans are determined by the first failed component (Galambos, 1978; Gumbel, 1958). In other words, as the system becomes more and more complex (contains more vital components, each being critical for survival), its life span distribution may asymptotically approach one of the only two theoretically possible limiting distributions—either Gompertz or Weibull (depending on the early kinetics of failure of system components). The two limit theorems in the statistics of extremes (Galambos, 1978; Gumbel,

1958) make the Gompertz and the Weibull failure laws as fundamental as are some other famous limiting distributions known in regular statistics, such as the normal distribution and the Poisson distribution. It is puzzling, however, why organisms prefer to die according to the Gompertz law, whereas technical devices typically fail according to the Weibull law. One possible explanation of this mystery is suggested later in this chapter.

Because of their fundamental importance for describing mortality kinetics, it may be interesting and useful to compare these two failure laws and their behavior. Figure 1.1A presents the dependence of the logarithm of the failure rate on age (Gompertz plot) for the Gompertz and the Weibull functions. Note that this dependence is strictly linear for the Gompertz function (as expected) and is concave-down for the Weibull function. So the Weibull function looks as if it is *decelerating* with age when compared to the Gompertz function.

Figure 1.1B presents the dependence of the logarithm of the failure rate on the *logarithm* of age (Weibull plot) for the Gompertz and the Weibull functions. Note that this dependence is strictly linear for the Weibull function (as anticipated) and is concave-up for the Gompertz function. So the Gompertz function looks as if it is *accelerating* with the *logarithm* of age when compared to the Weibull function.

This simple graphical method of data analysis is useful in practice because it allows researchers to determine easily whether particular data follow the Gompertz law or the Weibull law (or neither).

Two fundamental differences exist between the Weibull and the Gompertz functions. First, the Weibull function states that the system is immortal at starting age: when age x is equal to zero, the failure rate is equal to zero too, according to the Weibull formula. This means that the system should be initially

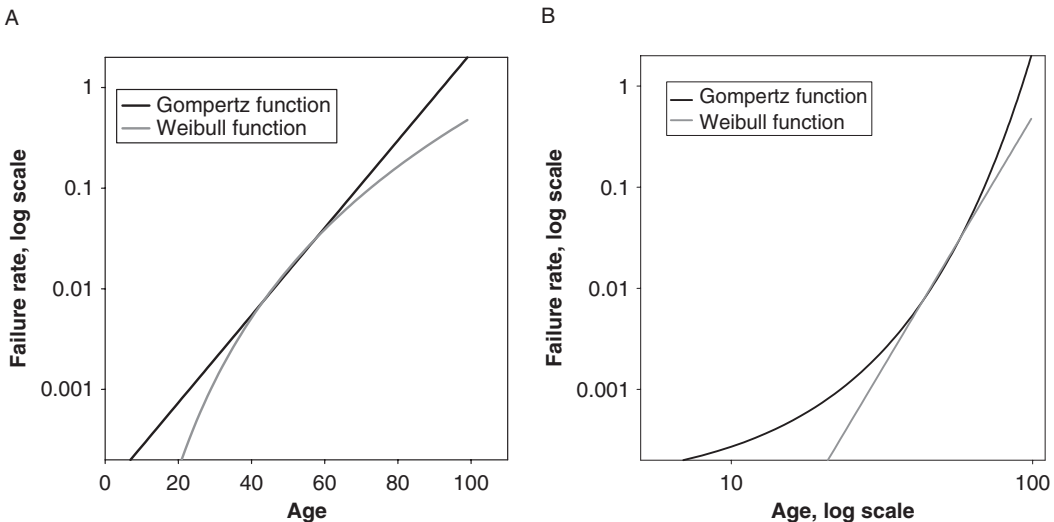

Figure 1.1 Comparison of the Gompertz and the Weibull functions in different coordinates. (A) Semi-log (Gompertz) coordinates. In this case, the Gompertz function produces a straight line, whereas the Weibull function generates a concave-down curve. (B) Log-log (Weibull) coordinates. In this case, the Weibull function produces a straight line, whereas the Gompertz function generates a concave-up curve. By plotting the death rate data in these coordinates, it is possible to determine graphically which particular formula provides the best fit (a better straight line) for the empirical data.

ideal (immortal) in order for the Weibull law to be applicable to it.

On the contrary, the Gompertz function states that the system is already vulnerable to failure at starting age: when age x is equal to zero, the failure rate is already above zero, equal to parameter R in the Gompertz formula. This means that partially damaged systems having some initial damage load are more likely to follow the Gompertz failure law, whereas initially perfect systems are more likely to follow the Weibull law. This profound difference between the two models is often obscured in real life by the period of initially high and then decreasing juvenile mortality that could not be explained by either model.

Second, there is a fundamental difference between the Gompertz and the Weibull functions regarding their response to misspecification of the starting age ("age zero"). This is an important issue because in biology there is an ambiguity regarding the choice of a "true" age, when aging starts. Legally, it is the moment of birth, which serves as a starting moment for age calculation. However, from a biological perspective, there are reasons to consider a starting age as a date either well before the birth date (the moment of conception in genetics, or a critical month of pregnancy in embryology), or long after the birth date (the moment of maturity, when the formation of a body is finally completed).

From a demographic perspective, the starting age at which aging begins is when death rates are the lowest and start to grow—this is about 10 years of age for humans. The uncertainty in starting age has very different implications for data analysis with the Gompertz and the Weibull functions. For the Gompertz function, misspecification of starting age is not as important because the shift in the age scale will still produce the same Gompertz function with the same slope parameter, α . The data generated by the

Gompertz function with different age shifts will all be linear and parallel to each other in the Gompertz plot.

The situation is very different for the Weibull function: it is linear in the Weibull plot for only one particular starting age, and any shifts in starting age produce a different function. Specifically, if a "true" starting age is larger than assumed, the resulting function will be a nonlinear concave-up curve in the Weibull plot, indicating model misspecification and leading to a bias in estimated parameters. Thus, researchers choosing the Weibull function for data analysis first have to resolve an uneasy biological problem: at what age does aging start?

An alternative graceful mathematical solution to this problem would be to move from a standard two-parameter Weibull function to a more general three-parameter Weibull function, which has an additional "location parameter" γ (Clark, 1975):

$$\mu(x) = a(x - \gamma)^b$$

for $x > \gamma$, and $\mu(x)$ is equal to zero otherwise.

Parameters of this formula, including the location parameter γ , could be estimated from the data through standard fitting procedures, thus providing a computational answer to the question "when does aging start?" However, this computational answer might be shocking to researchers unless they are familiar with the concept of initial damage load (Gavrilov & Gavrilova, 1991; 2001b; 2004a), which will be discussed later.

In addition to the Gompertz and the standard two-parameter Weibull laws, a more general failure law was suggested and theoretically justified using the system reliability theory. This law is known as the *binomial failure law* (Gavrilov & Gavrilova, 1991; 2001b), and it represents a special case of the three-parameter

Weibull function with a negative location parameter:

$$\mu(x) = a(x_0 + x)^b$$

The parameter x_0 in this formula is called the *initial virtual age of the system (IVAS)* (Gavrilov & Gavrilova, 1991, 2001b). This parameter has the dimension of time and corresponds to the age by which an initially ideal system would have accumulated as many defects as a real system already has at the starting age (at $x = 0$). In particular, when the system is initially undamaged, the initial virtual age of the system is zero, and the failure rate grows as a power function of age (the Weibull law). However, as the initial damage load increases, the failure kinetics starts to deviate from the Weibull law, and eventually it evolves to the Gompertz failure law at high levels of initial damage load. This is illustrated in Figure 1.2, which represents the Gompertz plot for the data generated by the binomial failure law with different levels of initial damage load (expressed in the units of initial virtual age).

Note that as the initial damage load increases, the failure kinetics evolves from the concave-down curves typical of the Weibull function to an almost linear dependence between the logarithm of failure rate and age (the Gompertz function). Thus, the binomial failure law unifies two different classes of distribution. The biological species dying according to the Gompertz law may have a high initial damage load, presumably because of developmental noise, and a clonal expansion of mutations that occurred in the early development (Gavrilov & Gavrilova, 1991, 2001b, 2003a, 2004a).

The concept of initial virtual age could be practically useful in analysis and interpretation of survival data because it allows us to take into account the initial damage load of the system when observations start. Moreover, this concept allows us to estimate the initial damage load

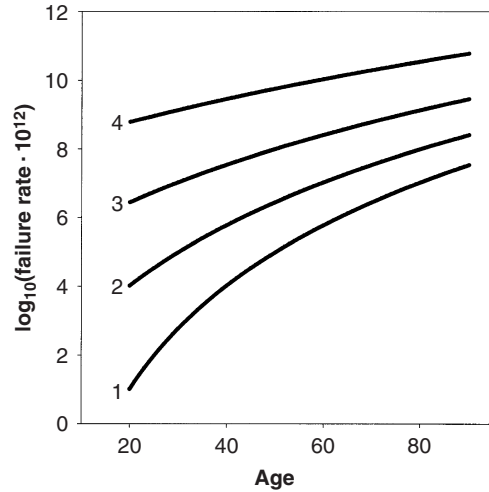

Figure 1.2 Failure kinetics of systems with different levels of initial damage. Dependence 1 is for an initially ideal system (with no damage load). Dependence 2 is for a system with an initial damage load equivalent to damage accumulated by a 20-year-old system. Dependencies 3 and 4 are for systems with an initial damage load equivalent to damage accumulated respectively by a 50-year-old system and a 100-year-old system. Note that high initial damage load transforms the Weibull curve into the Gompertz-like straight line.

1. The Weibull curve for initially ideal systems, $\mu(x) = ax^{10}$, $a = 10^{-24} \text{ year}^{-1}$ Graphs for initially damaged systems:
2. $\mu(x) = a(20 + x)^{10}$
3. $\mu(x) = a(50 + x)^{10}$
4. $\mu(x) = a(100 + x)^{10}$

Adapted from Gavrilov & Gavrilova, 2004c.

from experimental data through fitting procedures.

D. System Reliability and the Concept of Reliability Structure

A branch of reliability theory that studies reliability of an entire system given reliability of its components and its components' arrangement (reliability structure) is called *system reliability theory* (Rausand & Høyland, 2003). System reliability involves the study of the overall performance of systems of interconnected components. The main objective of system reliability is the construction of a model that represents the times-to-failure of the entire system based on the life

distributions of the components from which it is composed. Consideration of some basic ideas and models of the system reliability theory is important because living organisms may be represented as structured systems comprised of organs, tissues, and cells.

System reliability theory tells us that how components are arranged strongly affects the reliability of the whole system. The arrangement of components that are important for system reliability is also called *reliability structure* and is graphically represented by a schema of logical connectivity. It is important to understand that the model of logical connectivity focuses only on those components that are relevant for the functioning ability of the system. If the components do not play a direct role in a system's reliability, they usually are not included in the analyzed reliability structure (Rausand & Høyland, 2003). For example, organs of vision are not included in the reliability structure of a living organism if death is the only type of failure to be analyzed (complete failure of vision does not cause an immediate death of the organism). On the other hand, if disability is the type of failure under consideration, then organs of vision should be included in the schema of reliability structure. Therefore, reliability structure does not necessarily reflect a physical structure of the object.

There are two major types of component arrangement (connection) in the system: components connected in series and components connected in parallel (Rausand & Høyland, 2003). Here we consider a simple system of n statistically independent components, where failure of one component does not affect the failure rate of other components of the system.

1. Components Connected in Series

For a system of n independent components connected in series, the system fails if any one of the components fails, much like electrical circuits connected in series.

Thus, the failure of any one component results in the failure of the whole system, such as in Christmas tree lighting chains. Figure 1.3A shows a schema of the logical connectivity of the system in series.

This type of system is also called a *weakest-link system* (Ayyub & McCuen, 2003). In living organisms, many organs and tissues (heart, lung, liver, brain) are vital for the organism's survival, making them a good example of a series-connected component. Thus, the series connection indicates a logical connectivity

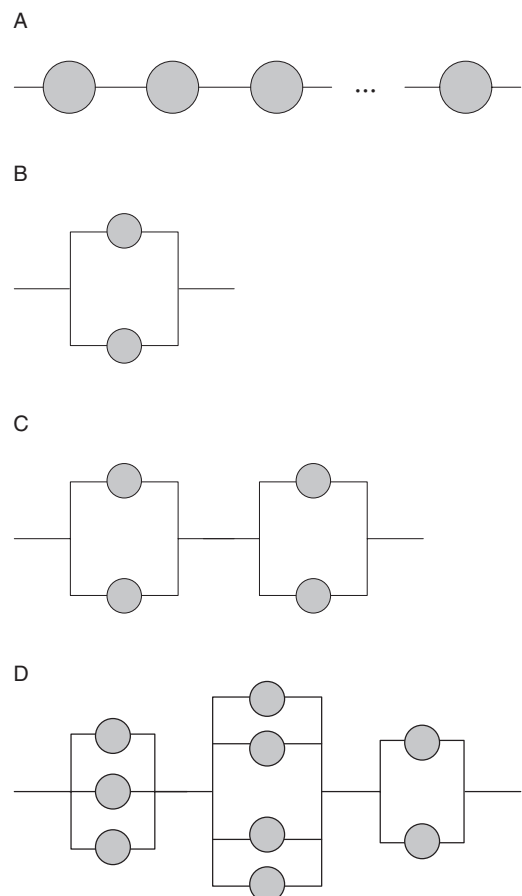

Figure 1.3 Logical schemas of systems with different types of elements connectivity. (A) A system connected in series. (B) A system connected in parallel. (C) A series-parallel system with equal redundancy of system components. (D) A series-parallel system with distributed redundancy.

but not necessarily a physical or an anatomical one. For example, a dominant deleterious mutation leading to a failure of a diploid organism corresponds to a schema of two components (alleles) connected in series (in terms of logical connectivity), although in fact these alleles are physically located at two different homologous chromosomes.

The reliability of a system in series (with independent failure events of the components), S_s , is a product of the reliabilities of its components:

$$S_s = p_1 p_2 \dots p_n$$

where $p_1 \dots p_n$ are the reliabilities of the system's components.

This formula explains why complex systems with many critical components are so sensitive to early failures of their components. For example, for a system built of 458 critical components, the initial period of a component's life when its cumulative risk of failure is only 1 percent corresponds to the end of a system's life, when 99 percent of systems have already failed. In other words, by the age when 99 percent of components are still functional ($p = 0.99$), a system built of 458 such critical components has only a 1 percent chance of remaining functional: $P_s = (0.99)^{458} \approx 0.01$. This discrepancy between the lifetimes of systems and the lifetimes of their components is increasing further with growing system complexity (numbers of critical components). Therefore, the early failure kinetics of components is very important in determining the failure kinetics of a complex system for almost its entire life. This helps simplify the analysis of complex system failure by focusing on the early failure kinetics of system components.

The failure rate of a system connected in series is a sum of failure rates of its components (Barlow *et al.*, 1965):

$$\mu_s = \mu_1 + \mu_2 + \dots + \mu_n$$

If failure rates of all components are equal, the failure rate of the system with n components is $n\mu$. It follows from this formula that if a system's components do not age ($\mu_n = \text{const}$), the entire system connected in series does not age either.

2. Components Connected in Parallel

A parallel system of n independent components fails only when all the components fail (such as in electrical circuits connected in parallel). The logical structure of a parallel system is presented in Figure 1.3B.

An example of a parallel system is a system with components performing an identical function. This function will be destroyed only when *all* the components fail. The number of additional components with the same function in a parallel structure is called a redundancy or a reserve of the system. In living organisms, vital organs and tissues (such as the liver, kidney, or pancreas) consist of many cells performing one and the same specialized function. A recessive deleterious mutation leading to a failure of a diploid organism represents a classic example of two components (alleles) connected in parallel.

For a parallel system with n independent components, the probability of a system's failure, Q , is a product of probabilities of failure for its components, q :

$$Q_s = q_1 q_2 \dots q_n \\ = (1 - p_1)(1 - p_2) \dots (1 - p_n)$$

Hence, the reliability of a parallel system, S_s , is related to the reliability of its components in the following way:

$$S_s = 1 - Q_s = 1 - (1 - p_1)(1 - p_2) \dots (1 - p_n)$$

The reliability of a parallel system with components of equal reliability, p , is:

$$S_s = 1 - (1 - p)^n$$

What is important here is the emergence of aging in parallel systems: a parallel system is aging even if it is built of non-aging components with a constant failure rate (see more details in Section IV).

In the real world, most systems are more complex than simply series and parallel structures, but in many cases they can be represented as combinations of these structures.

3. More Complex Types of Reliability Structures

The simplest combination of the two reliability structures is a series-parallel system with equal redundancy, shown in Figure 1.3C.

A general series-parallel system is a system of m subsystems (blocks) connected in series, where each block is a set of n components connected in parallel. It turns out that even if the components themselves are not aging, the system as a whole has an aging behavior—its failure rate grows with age according to the Weibull law and then levels off at advanced ages (Gavrilov & Gavrilova, 1991, 2001b, 2003b). This type of system is important to consider because a living organism can be presented as a system of critical vital organs and tissues connected in series, while each organ consists of specialized cells connected in parallel. The reliability model for this type of system is described in more detail in Section IV.

Another type of reliability structure, a series-parallel system with distributed redundancy, was introduced by Gavrilov and Gavrilova (1991). The series-connected blocks of this system have non-equal redundancy (different numbers of elements connected in parallel), and the elements are distributed between the system's blocks according to some particular distribution law (see Figure 1.3D).

Gavrilov and Gavrilova (1991, 2001b) studied the reliability and failure rate of series-parallel systems with distributed

redundancy for two special cases: (1) the redundancy distributed within an organism according to the Poisson law or (2) according to the binomial law. They found that the failure rate of such systems initially grows according to the Gompertz law (in the case of the Poisson distributed redundancy) or binomial failure law (in the case of the binomially distributed redundancy). At advanced ages, the failure rate for both systems asymptotically approaches an upper limit (mortality plateau). Reliability models for these systems are described in Section VI.

Now when the basic concepts of reliability theory are discussed, we may proceed to link them to empirical observations on aging and mortality.

III. Mortality, Failure, and Aging in Biological and Technical Systems

A. Failure Kinetics in Biological and Technical Systems

There is a striking similarity between living organisms and technical devices in the general age pattern of their failures—in both cases, the failure rate usually follows the so-called “bathtub curve” (see Figure 1.4).

The bathtub curve of failure rate is a classic concept presented in many textbooks on reliability theory (Ayyub & McCuen, 2003; Barlow & Proschan, 1975; Rausand & Høyland, 2003). The curve consists of three periods. Initially, the failure rates are high and decrease with age. This period is called the “working-in” period, and the period of “burning-out” of defective components. For example, the risk for a new computer to fail is often higher at the very start, but then those computers that did not fail initially work normally afterwards. The same period exists early in life for most living organisms, including humans, and it is called the *infant mortality period*.

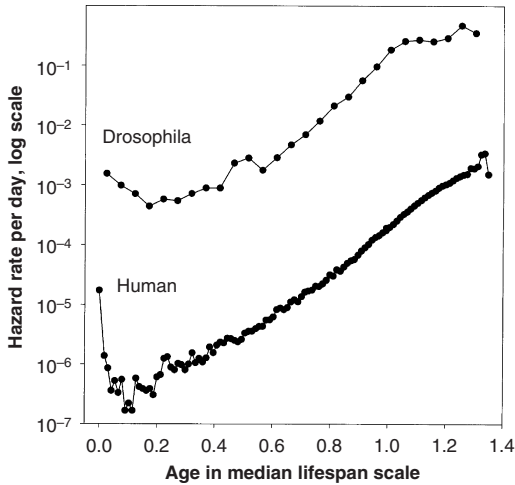

Figure 1.4 “Bathtub” mortality curves for humans and fruit flies. Mortality rates (vertical axis) are calculated in identical units (deaths per day per individual) for both species, whereas the age scale (horizontal axis) is normalized by dividing by the median life span of the species to allow data comparison (a similar approach to age scaling was used by Pearl & Miner, 1935, and Carnes *et al.*, 1998). Mortality for *Drosophila melanogaster* was calculated using data published by Hall (1969). Mortality for humans was calculated using the official Swedish female life table for 1985.

Then follows the second period, called the *normal working period*, corresponding to an age of low and approximately constant failure rates. This period also exists in humans, but unfortunately it is rather short (10 to 15 years) and ends too soon.⁴

Then the third period, the *aging period*, starts, which involves an inexorable rise

⁴In countries with low child mortality, this age window with minimal death rates has recently broadened to about 5 to 15 years of age. When the death rates in this age interval are presented in logarithmic scale (sensitive to outliers that are close to zero levels of mortality), this may create an impression of large *relative* differences in death rates. However the death rates are so low in this age group that the absolute differences in death rates are negligible, and it is therefore safe to assume that death rates are “approximately constant.”

in the failure rate with age. In most living organisms, including humans, this rise in failure rates follows an explosive exponential trajectory (the Gompertz curve). For humans, the aging period lies approximately within the interval of 20 to 100 years.

Thus, there is a remarkable similarity in the failure patterns of technical and biological systems. This similarity is reinforced further by the fact that at extreme old ages there is a fourth period common to both technical devices and living organisms (Economos, 1979, 1980, 1983, 1985). This period is known in biology as a period of late-life mortality leveling-off (Carey & Liedo, 1995; Clark & Guadalupe, 1995; Economos, 1979; Fukui *et al.*, 1993, 1996; Vaupel *et al.*, 1998), and also as the late-life mortality deceleration law (Fukui *et al.*, 1993, 1996; Khazaeli *et al.*, 1996; Partridge & Mangel, 1999).

Remarkably similar failure patterns of biological and technical systems indicate that there may be some very general principles of system aging and failure (which will be discussed later), despite the obvious differences in specific underlying mechanisms of aging.

B. Mortality Laws in the Biology of Life Span

Attempts to develop a fundamental quantitative theory of aging, mortality, and life span have deep historical roots. In 1825, the British actuary Benjamin Gompertz discovered a law of mortality (Gompertz, 1825) known today as the Gompertz law (Finch, 1990; Gavrilov & Gavrilova, 1991; Olshansky & Carnes, 1997; Strehler, 1978). Specifically, he found that the force of mortality increases in geometrical progression with the age of adult humans. According to the Gompertz law, human mortality rates double about every 8 years of adult age (Finch, 1990; Gavrilov & Gavrilova, 1991; Gompertz, 1825;

Makeham, 1860; Strehler, 1978). An exponential (Gompertzian) increase in death rates with age is observed for many biological species including fruit flies (*Drosophila melanogaster*) (Gavrilov & Gavrilova, 1991), nematodes (Brooks *et al.*, 1994; Johnson, 1987, 1990), mosquitoes (Gavrilov, 1980), human lice (*Pediculus humanus*) (Gavrilov & Gavrilova, 1991), flour beetles (*Tribolium confusum*) (Gavrilov & Gavrilova, 1991), mice (Kunstyr & Leuenberger, 1975; Sacher, 1977), rats (Gavrilov & Gavrilova, 1991), dogs (Sacher, 1977), horses (Strehler, 1978), mountain sheep (Gavrilov, 1980), and baboons (Bronikowski *et al.*, 2002).

Gompertz also proposed the first mathematical model to explain the exponential increase in mortality rate with age (Gompertz, 1825). In reality, failure rates of organisms may contain both non-aging and aging terms, as, for example, in the case of the *Gompertz-Makeham law* of mortality (Finch, 1990; Gavrilov & Gavrilova, 1991; Makeham, 1860; Strehler, 1978):

$$\mu(x) = A + Re^{\alpha x}$$

In this formula, the first, age-independent term (Makeham parameter, A) designates the constant, “non-aging” component of the failure rate (presumably due to external causes of death, such as accidents and acute infections), whereas the second, age-dependent term (the Gompertz function, $Re^{\alpha x}$) designates the “aging” component, presumably due to deaths from age-related degenerative diseases such as cancer and heart disease.

The validity of the Gompertz-Makeham law of mortality can be illustrated graphically when the logarithms of death rates without the Makeham parameter ($\mu_x - A$) are increasing with age in a linear fashion (see Figure 1.6). The log-linear increase in death rates (adjusted for the Makeham term) with age is indeed a very common phenomenon for many

human populations from 35 to 70 years of age (Gavrilov & Gavrilova, 1991).

Note that the slope coefficient α characterizes an “apparent aging rate” (the rapidity of age-deterioration in mortality); if α is equal to zero, there is no apparent aging (death rates do not increase with age).

At advanced ages (after age 80), the “old-age mortality deceleration” takes place: death rates increase with age at a slower pace than expected from the Gompertz-Makeham law. This mortality deceleration eventually produces the “late-life mortality leveling-off” and “late-life mortality plateaus” at extreme old ages (Curtsinger *et al.*, 1992; Economos, 1979, 1983; Gavrilov & Gavrilova, 1991; Greenwood and Irwin, 1939; Vaupel *et al.*, 1998). Actuaries—including Gompertz himself—first noted this phenomenon and proposed a logistic formula for mortality growth with age in order to account for mortality falloff at advanced ages (Beard, 1959, 1971; Perks, 1932). Greenwood and Irwin (1939) provided a detailed description of this phenomenon in humans and even made the first estimates for the asymptotic value of the upper limit to human mortality (see also the chapter by Curtsinger *et al.* in this volume and review by Olshansky, 1998). According to their estimates, the mortality kinetics of long-lived individuals is close to the law of radioactive decay with half-time approximately equal to 1 year.

The same phenomenon of “almost non-aging” survival dynamics at extreme old ages is detected in many other biological species. In some species, the mortality plateau can occupy a sizable part of their life (see Figure 1.5).

Biologists have been well aware of mortality leveling-off since the 1960s. For example, Lindop (1961) and Sacher (1966) discussed mortality deceleration in mice. Strehler and Mildvan (1960) considered mortality deceleration at advanced ages as a prerequisite for all mathematical models

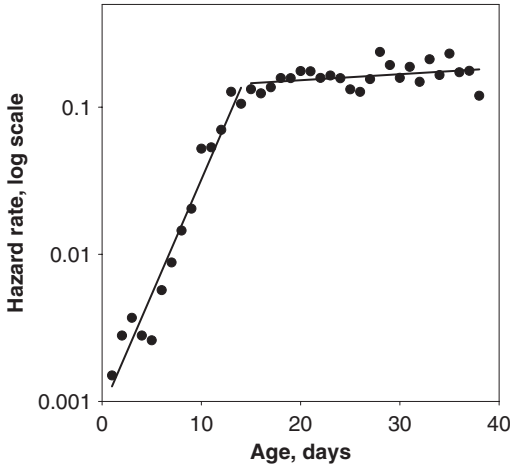

Figure 1.5 Mortality leveling-off in a population of 4,650 male house flies. Hazard rates were computed using the life table of the house fly *Musca domestica*, published by Rockstein & Lieberman (1959).

of aging. Later, Economos published a series of articles claiming a priority in the discovery of a “non-Gompertzian paradigm of mortality” (Economos, 1979, 1980, 1983, 1985). He found that mortality leveling-off is observed in rodents (guinea pigs, rats, and mice) and invertebrates (nematodes, shrimps, bdelloid rotifers, fruit flies, and degenerate medusae *Campanularia Flexuosa*). In the 1990s, the phenomenon of mortality deceleration and leveling-off became widely known after publications demonstrated mortality leveling-off in large samples of *Drosophila melanogaster* (Curtisinger *et al.*, 1992) and medflies (*Ceratitis capitata*) (Carey *et al.*, 1992), including isogenic strains of *Drosophila* (Curtisinger *et al.*, 1992; Fukui *et al.*, 1993, 1996). Mortality plateaus at advanced ages have been observed for some other insects, including the house fly (*Musca vicina*), blowfly (*Calliphora erythrocephala*) (Gavrilov, 1980), fruit flies (*Anastrepha ludens*, *Anastrepha obliqua*, *Anastrepha serpentine*), parasitoid wasp (*Diachasmimorpha longicaudtis*) (Vaupel *et al.*, 1998), and bruchid beetle (*Callosobruchus maculatus*) (Tatar *et al.*, 1993). Interestingly, the failure kinetics of

manufactured products (steel samples, industrial relays, and motor heat insulators) also demonstrates the same “non-aging” pattern at the end of their “life span” (Economos, 1979).

The phenomenon of late-life mortality leveling-off presents a theoretical challenge to many models and theories of aging. One interesting corollary from these intriguing observations is that there seems to be no fixed upper limit for individual life span (Gavrilov, 1984; Gavrilov & Gavrilova, 1991; Wilmoth, 1997).⁵

This observation calls for a very general explanation of this apparently paradoxical “no aging at extreme ages” phenomenon, which will be discussed later in this chapter.

Another empirical observation, the *compensation law of mortality*, in its strong form refers to *mortality convergence*, when higher values for the slope parameter α (in the Gompertz function) are compensated by lower values of the intercept parameter R in different populations of a given species:

$$\ln(R) = \ln(M) - B\alpha$$

where B and M are universal species-specific invariants.

Sometimes this relationship is also called the *Strehler-Mildvan correlation* (Strehler, 1978; Strehler & Mildvan, 1960), although that particular correlation was largely an artifact of the opposite biases in parameters estimation caused by not taking into account the age-independent mortality component, the Makeham term A (see Gavrilov & Gavrilova, 1991; Golubev, 2004). Parameter B is called the species-

⁵Note that there is no mathematical limit to life span, even with exponential growth of mortality force (hazard rate). However, this mathematical limit exists if the Gompertz law of exponential growth is applied to probability of death (Gavrilov & Gavrilova, 1991).

specific life span (95 years for humans), and parameter M is called the species-specific mortality rate (0.5 year^{-1} for humans). These parameters are the coordinates for convergence of all the mortality trajectories into one single point (within a given biological species), when extrapolated by the Gompertz function (Gavrilov & Gavrilova, 1979, 1991). This means that high mortality rates in disadvantaged populations (within a given species) are compensated for by a low apparent “aging rate” (longer mortality doubling period). As a result of this compensation, the relative differences in mortality rates tend to decrease with age within a given biological species (see Figure 1.6).

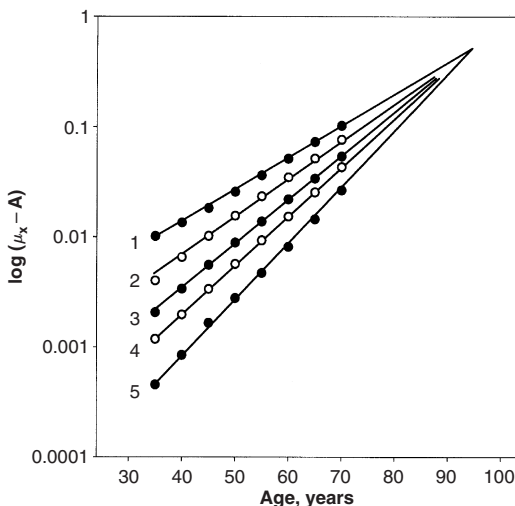

Figure 1.6 Compensation law of mortality. Convergence of mortality rates in different populations at advanced ages. Death rates (with removed age-independent external mortality component, Makeham parameter A) are plotted in a log scale as a function of age in the following countries:

1. India, 1941–1950, males; $A = 0.00676 \text{ year}^{-1}$
2. Turkey, 1950–1951, males; $A = 0.00472 \text{ year}^{-1}$
3. Kenya, 1969, males; $A = 0.00590 \text{ year}^{-1}$
4. England and Wales, 1930–1932, females; $A = 0.00246 \text{ year}^{-1}$
5. Norway, 1956–1960, females; $A = 0.00048 \text{ year}^{-1}$

Computed using data from the UN Demographic Yearbook (1967; 1975). Adapted from Gavrilov & Gavrilova, 2003b.

In those cases when the compensation law of mortality is not observed in its strong form, it may still be valid in its weak form—i.e., the relative differences in mortality rates of compared populations tend to decrease with age in many species. Explanation of the compensation law of mortality is a great challenge for many theories of aging and longevity (Gavrilov & Gavrilova, 1991; Strehler, 1978).

There are some exceptions both from the Gompertz law of mortality and the compensation law of mortality that have to be understood and explained. There were reports that in some cases, the organisms die according to the Weibull (power) law (Eakin *et al.*, 1995; Hirsch & Peretz, 1984; Hirsch *et al.*, 1994; Janse *et al.*, 1988; Ricklefs & Scheuerlein, 2002; Vanfleteren *et al.*, 1998). The Weibull law is more commonly applicable to technical devices (Barlow & Proschan, 1975; Rigdon & Basu, 2000; Weibull, 1951), whereas the Gompertz law is more common in biological systems (Finch, 1990; Gavrilov & Gavrilova, 1991; Strehler, 1978). Comparative meta-analysis of 129 life tables for fruit flies as well as 285 life tables for humans demonstrates that the Gompertz law of mortality provides a much better data fit for each of these two biological species compared to the Weibull law (see Gavrilov & Gavrilova, 1991, pp. 55–56, 68–72). Possible explanations for why organisms prefer to die according to the Gompertz law and technical devices typically fail according to the Weibull law are provided elsewhere (Gavrilov & Gavrilova, 1991, 2001b) and will be discussed later in this chapter (see Sections V–VI).

Thus, a comprehensive theory of species aging and longevity should provide answers to the following questions:

1. Why do most biological species deteriorate with age (i.e., die more often as they grow older), whereas some primitive

organisms do not demonstrate such a clear mortality growth with age (Austad, 2001; Finch, 1990; Haranghy & Balázs, 1980; Martinez, 1998)?

2. Specifically, why do mortality rates increase exponentially with age in many adult species (Gompertz law)? How should we handle cases when the Gompertzian mortality law is not applicable?

3. Why does the age-related increase in mortality rates vanish at older ages? Why do mortality rates eventually decelerate compared to predictions of the Gompertz law, demonstrating mortality leveling-off and a late-life mortality plateau?

4. How do we explain the so-called compensation law of mortality (Gavrilov & Gavrilova, 1991)?

Any comprehensive theory of human aging has to explain these last three rules, known collectively as mortality, or failure, laws. And reliability theory, by way of a clutch of equations, covers all of them (Gavrilov & Gavrilova, 1991, 2001b), as will be discussed later.

C. Loss of Redundancy (e.g., Cell Numbers) with Age

Many age changes in living organisms can be explained by cumulative effects of cell loss (either physical or functional) over time. For example, such very common phenomenon as hair graying with age is caused by depletion of hair follicle melanocytes (Commo *et al.*, 2004). Melanocyte density in human epidermis declines gradually with age, at a rate of approximately 0.8 percent per year (Gilchrest *et al.*, 1979). Hair graying is a relatively benign phenomenon, but cell loss can also lead to more serious consequences.

Recent studies suggest that such conditions as atherosclerosis, atherosclerotic inflammation, and consequent thromboembolic complications could be linked

to age-related exhaustion of progenitor cells responsible for arterial repair (Goldschmidt-Clermont, 2003; Libby, 2003; Rauscher *et al.*, 2003). Taking these progenitor cells from young mice and adding them to experimental animals prevents atherosclerosis progression and atherosclerotic inflammation (Goldschmidt-Clermont, 2003; Rauscher *et al.*, 2003).

Age-dependent decline in cardiac function has recently been linked to the failure of cardiac stem cells to replace dying myocytes with new functioning cells (Capogrossi, 2004). Also, it was found that aging-impaired cardiac angiogenic function could be restored by adding endothelial precursor cells derived from young bone marrow (Edelberg *et al.*, 2002).

Chronic renal failure is found to be associated with a decreased number of endothelial progenitor cells (Choi, 2004). People with diminished numbers of nephrons in their kidneys are more likely to suffer from hypertension (Keller *et al.*, 2003), and the number of glomeruli decreases with human age (Nyengaard & Bendtsen, 1992).

Humans generally lose 30 to 40 percent of their skeletal muscle fibers by age 80 (Leeuwenburgh, 2003), which contributes to such adverse health outcomes as sarcopenia and frailty. Loss of striated muscle cells in such places as the rhabdosphincter, from 87.6 percent in a 5-week-old child to only 34.2 percent in a 91-year-old person, has obvious implications for urological failure: incontinence (Strasser *et al.*, 2000).

A progressive loss of dopaminergic neurons in substantia nigra results in Parkinson's disease, loss of GABAergic neurons in striatum produces Huntington's disease, loss of motor neurons is responsible for amyotrophic lateral sclerosis, and loss of neurons in the cortex causes Alzheimer's disease over time (Baizabal *et al.*, 2003). A study of cerebella from

normal males age 19 to 84 revealed that the global white matter was reduced by 26 percent with age, and a selective 40 percent loss of both Purkinje and granule cells was observed in the anterior lobe (Andersen *et al.*, 2003).

Furthermore, a 30 percent loss of volume, mostly due to a cortical volume loss, was found in the anterior lobe, which is predominantly involved in motor control (Andersen *et al.*, 2003). Even if the loss of the volume in various brain regions is caused by cell atrophy rather than cell death, it is still indicative for the loss of redundancy (reserve capacity) with age.

Loss of cells with age is not limited to the human species; it is observed in other animals as well. For example, a nematode *C. elegans* demonstrates a gradual, progressive deterioration of muscle, resembling human sarcopenia (Herndon *et al.*, 2002). The authors of this study also found that the behavioral ability of nematode was a better predictor of life expectancy than chronological age.

Interestingly, recent studies have found that caloric restriction can prevent cell loss (Cohen *et al.*, 2004; McKiernan *et al.*, 2004), which may explain why caloric restriction delays the onset of numerous age-associated diseases and can significantly increase life span in mammals (Masoro, 2003). It should be acknowledged, however, that the hypothesis that aging occurs largely because of cell loss remains a subject of debate (Van Zant & Liang, 2003).

In terms of reliability theory, the loss of cells with age is a loss of system redundancy, and therefore this chapter will focus further on the effects of redundancy loss on system aging and failure. Note that the loss of redundancy does not necessarily imply losing cell numbers, because the loss of cell functionality (decrease in proportion of functional cells) could produce the same adverse health outcomes with age.

IV. Explanations of Aging Phenomena Using Reliability Theory

A. Problem of the Origin of Aging

The aging period for most species occupies the greater part of their life span, therefore any model of mortality must explain the existence of this period. It turns out that the phenomena of mortality increase with age and the subsequent mortality leveling-off is theoretically predicted to be an inevitable feature of all reliability models that consider aging as a progressive accumulation of random damage (Gavrilov & Gavrilova, 1991). The detailed mathematical proof of this prediction for some particular models is provided elsewhere (Gavrilov & Gavrilova, 1991, 2001b) and is briefly described in the next sections of this chapter.

The simplest schema, which demonstrates an emergence of aging in a redundant system, is presented in Figure 1.7.

If the destruction of an organism occurs not in one but in two or more sequential random stages, this is sufficient for the phenomenon of aging (mortality increase) to appear and then to vanish at older ages. Each stage of destruction corresponds to one of the organism's vitally important structures being damaged. In the simplest

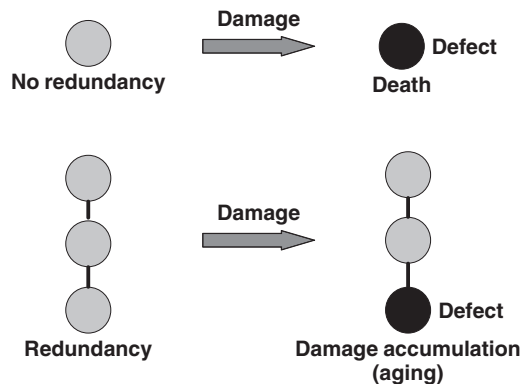

Figure 1.7 Redundancy creates both damage tolerance and damage accumulation (aging).

organisms with unique critical structures, this damage usually leads to death. Therefore, defects in such organisms do not accumulate, and the organisms themselves do not age—they just die when damaged. For example, the inactivation of microbial cells and spores exposed to a hostile environment (such as heat) follows approximately a non-aging mortality kinetics; their semi-logarithmic survival curves are almost linear (Peleg *et al.*, 2003). This observation of non-aging survival dynamics is extensively used in the calculation of the efficacy of sterilization processes in medicine and food preservation (Brock *et al.*, 1994; Davis *et al.*, 1990; Jay, 1996). A similar non-aging pattern of inactivation kinetics is often observed for viruses (Andreadis & Palsson, 1997; Kundi, 1999) and enzymes (Gouda *et al.*, 2003; Kurganov, 2002).

In more complex systems with many vital structures and significant redundancy, every occurrence of damage does not lead to death (unless the environment is particularly hostile). Defects accumulate, therefore, giving rise to the phenomenon of aging (mortality increase). Thus, aging is a direct consequence (tradeoff) of a system's redundancies, which ensure increased reliability and an increased life span of more complex organisms. As defects accumulate, the redundancy in the number of elements finally disappears. As a result of this *redundancy exhaustion*, the organism degenerates into a system with no redundancy (that is, a system with elements connected in series, in which any new defect leads to death). In such a state, no further accumulation of damage can be achieved, and the mortality rate levels off.

The positive effect of a system's redundancy is *damage tolerance*, which decreases the risk of failure (mortality) and increases life span. However, damage tolerance makes it possible for damage to be tolerated and accumulated over time, thus producing the aging phenomenon.

The next section provides a mathematical illustration of these ideas.

B. A Simple Model with Parallel Structure

In this section we show that a system built of non-aging components demonstrates an aging behavior (mortality growth with age) and subsequent mortality leveling-off.

Consider a parallel system built of n non-aging elements with a constant failure rate k and reliability (survival) function e^{-kx} (see also Figure 1.3B). In this case, the reliability function of the entire parallel system is as follows (see also Section II.D):

$$S(x) = 1 - (1 - p)^n = 1 - (1 - e^{-kx})^n$$

This formula corresponds to the simplest case when the failure of elements is statistically independent. More complex models would require specific assumptions or prior knowledge of the exact type of the interdependence in the elements' failure. One of such models known as "the model of the avalanche-like destruction" is described elsewhere (see pp. 246–251 in Gavrilov & Gavrilova, 1991).

Consequently, the failure rate of the entire system, $\mu(x)$, can be written as follows:

$$\begin{aligned} \mu(x) &= -\frac{dS(x)}{S(x)dx} = \frac{nk e^{-kx}(1 - e^{-kx})^{n-1}}{1 - (1 - e^{-kx})^n} \\ &\approx nk^n x^{n-1} \end{aligned}$$

when $x \ll 1/k$ (early-life period approximation, when $1 - e^{-kx} \approx kx$);

$$\approx k$$

when $x \gg 1/k$ (late-life period approximation, when $1 - e^{-kx} \approx 1$).

Thus, the failure rate of a system initially grows as a power function of age

(the Weibull law). Then, the tempo at which the failure rate grows declines, and the failure rate approaches asymptotically an upper limit equal to k . Here we should pay attention to three significant points. First, a system constructed of non-aging elements is now behaving like an aging object; that is, aging is a direct consequence of the redundancy of the system (redundancy in the number of elements). Second, at very high ages, the phenomenon of aging apparently disappears (failure rate levels off) as redundancy in the number of elements vanishes. The failure rate approaches an upper limit, which is totally independent of the initial number of elements but coincides with the rate of their loss (parameter k). Third, the systems with different initial levels of redundancy (parameter n) will have very different failure rates in early life, but these differences will eventually vanish as failure rates approach the upper limit determined by the rate of elements' loss (parameter k). Thus, the compensation law of mortality (in its weak form) is an expected outcome of this illustrative model.

Note also that the identical parallel systems in this example do not die simultaneously when their elements fail by chance. A common view in biology is the idea that all members of a homogeneous population in a hypothetical constant environment should have identical life spans (die simultaneously) so that the survival curve of such a population would look like a rectangle. This idea stems from the basic principles of quantitative genetics, which assume implicitly that every animal of a given genotype has the same genetically determined life span so that all variation of survival time around a genotype mean results from the environmental variance. George Sacher (1977) pointed out that this concept is not applicable to longevity and used an analogy with radioactive decay in his arguments.

Even the simplest parallel system has a specific life span distribution determined entirely by a stochastic nature of the aging process. In order to account for this stochasticity, it was proposed that researchers use a stochastic variance component of life span in addition to genetic and environmental components of phenotypic life span variance (Gavrilov & Gavrilova, 1991). The stochastic nature of a system's destruction also produces heterogeneity in an initially homogeneous population. This kind of induced heterogeneity was observed in isogenic strains of nematodes in which aging resulted in substantial heterogeneity in behavioral capacity among initially homogeneous worms kept in controlled environmental conditions (Herndon *et al.*, 2002).

The graph shown in Figure 1.8 depicts mortality trajectories for five systems with different degrees of redundancy.

System 1 has only one unique element (no redundancy), and it has the highest failure rate, which does not depend on age (no aging). System 2 has two elements connected in parallel (one extra element is redundant), and the failure rate initially increases with age (aging appears). The apparent rate of aging can be characterized by a slope coefficient that is equal to 1. Finally, the failure rate levels off at advanced ages. Systems 3, 4, and 5 have, respectively, three, four, and five elements connected in parallel (two, three, and four extra elements are redundant), and the failure rate initially increases with age at an apparent aging rate (slope coefficient) of 2, 3, and 4, respectively. Finally, the mortality trajectories of each system level off at advanced ages at exactly the same upper limit to the mortality rate.

This computational example illustrates the following general ideas: (1) Aging is a direct consequence of a system's redundancy, and the expression of aging is directly related to the degree of a system's redundancy. Specifically, an apparent

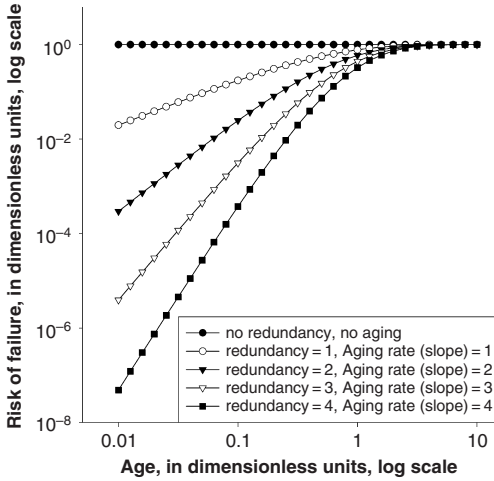

Figure 1.8 Failure kinetics of systems with different levels of redundancy. The dependence of the logarithm of mortality force (failure rate) on the logarithm of age in five systems with different levels of redundancy (computer simulation experiment). Dependence 1 is for the system containing only one unique element (no redundancy). Dependence 2 is for the system containing two elements connected in parallel (degree of redundancy = 1). Dependencies 3, 4, and 5 are for systems containing, respectively, three, four, and five elements connected in parallel (with increasing levels of redundancy). The scales for mortality rates (vertical axis) and for age (horizontal axis) are presented in dimensionless units (μ/k for mortality rates and kx for age to ensure the generalizability of the results (invariance of graphs on failure rate of the elements in the system, parameter k). Also, the log scale is used to explore the system behavior in a wide range of ages (0.01 to 10 units) and failure rates (0.00000001 to 1.0 units). Adapted from Gavrilov & Gavrilova, 2003b, 2004c.

relative aging rate is equal to the degree of redundancy in parallel systems. (2) All mortality trajectories tend to converge with age so that the compensation law of mortality is observed. (3) All mortality trajectories level off at advanced ages, and a mortality plateau is observed. Thus, the major aging phenomena (aging itself, the compensation law of mortality, late-life mortality deceleration, and late-life mortality plateaus) are already observed in the simplest redundant systems. However, to explain the Gompertz law of

mortality, an additional idea should be taken into account (see the next section).

V. The Idea of High Initial Damage Load: The HIDL Hypothesis

In 1991, Gavrilov and Gavrilova suggested an idea that early development of living organisms produces an exceptionally high load of initial damage, which is comparable with the amount of subsequent aging-related deterioration accumulating during the rest of the entire adult life.

This idea of High Initial Damage Load (the HIDL hypothesis) predicts that even small progress in optimizing the early developmental processes can potentially result in a remarkable prevention of many diseases in later life, postponement of aging-related morbidity and mortality, and significant extension of healthy life span (Gavrilov & Gavrilova, 1991, 2001b, 2003b, 2004a). Thus, the idea of early-life programming of aging and longevity may have important practical implications for developing early-life interventions in promoting health and longevity.

Although this idea may look like a counterintuitive assumption, it fits well with many empirical observations on massive cell losses in early development. For example, the female human fetus at age 4 to 5 months possesses 6 to 7 million eggs (oocytes). By birth, this number drops to 1 to 2 million and declines even further. At the start of puberty in normal girls, there are only 0.3 to 0.5 million eggs—only 4 to 8 percent of initial numbers (Finch & Kirkwood, 2000; Gosden, 1985; Wallace & Kelsey, 2004). It is now well established that the exhaustion of the ovarian follicle numbers over time is responsible for menopause (reproductive aging and failure), and women having higher ovarian reserve have longer reproductive life span (Wallace & Kelsey,

2004). When young ovaries were transplanted to old post-reproductive mice, their reproductive function was restored for a while (Cargill *et al.*, 2003). This example illustrates a general idea that aging occurs largely because of cell loss, which starts early in life.

Massive cell losses in early development create differences between organisms in the numbers of remaining cells, which can be described by the binomial distribution or, at particularly high levels of cell losses, by the Poisson distribution. This, in turn, can produce a quasi-exponential (Gompertzian) pattern of age-specific mortality kinetics with a subsequent mortality deceleration (Gavrilov & Gavrilova, 1991). In some species, including *C. elegans*, the developmental loss of cells seems to be very precise. If adult individuals are identical in the initial numbers of functional cells, one can expect that mortality kinetics in such cases would be closer to the Weibull law rather than the Gompertz law. However, the Gompertz law also can be expected for initially identical organisms if the critical vital organs within a given organism differ by their cell numbers (Gavrilov & Gavrilova, 1991, pp. 252–264; 2001b).

Mathematical proof for this statement was published elsewhere (see Gavrilov & Gavrilova, 1991, pp. 264–272) and will be briefly summarized in Section VI. Here we concentrate on the substantive discussion of the idea of high initial damage load in biological systems.

A. Differences Between Biological and Technical Systems

Biological systems are different from technical devices in at least two aspects. The first fundamental feature of biological systems is that, in contrast to technical (artificial) devices that are constructed out of previously manufactured and tested components, organisms form themselves in

ontogenesis through a process of self-assembly out of *de novo* forming and externally untested elements (cells). Moreover, because organisms are formed from a single cell, any defects in early life such as deleterious mutations or deleterious epigenetic modifications (i.e., genomic imprinting) can proliferate by mechanism of clonal expansion, forming large clusters of damaged cells. This proliferation of defects during development of biological systems can make them highly damaged by the time they are formed.

The second property of organisms is the extraordinary degree of miniaturization of their components (the microscopic dimensions of cells as well as the molecular dimensions of information carriers like DNA and RNA), permitting the creation of a huge redundancy in the number of elements. Thus, we can expect that for living organisms, in distinction to many technical (manufactured) devices, the reliability of the system is achieved not by the high initial quality of all the elements but by their huge numbers (redundancy).

The fundamental difference in the manner in which the system is formed (external assembly in the case of technical devices and self-assembly in the case of biological systems) has two important consequences. First, it leads to the macroscopicity of components in technical devices compared to biosystems, since technical devices are assembled “top-down” with the participation of a macroscopic system (man) and must be suitable for this macroscopic system to use (i.e., commensurate with man). Organisms, on the other hand, are assembled “bottom-up” from molecules and cells, resulting in an exceptionally high degree of miniaturization of the component parts. Second, since technical devices are assembled under the control of man, the opportunities to pretest components (external quality control) are incomparably greater than in the self-assembly of

biological systems. This inevitably leads to organisms being “littered” with a great number of defective elements. As a result, the reliability of technical devices is assured by the high quality of elements (*fault avoidance*), with a strict limit on their numbers because of size and cost limitations, whereas the reliability of biological systems is assured by an exceptionally high degree of redundancy to overcome the poor quality of some elements (*fault tolerance*).

B. Some Examples Illustrating the HIDL Hypothesis

The idea that living organisms start their lives with a large number of defects is not a new one. Biological justification for this idea was discussed by Dobzhansky, who noted that, from the biological perspective, Hamlet’s “thousand natural shocks that flesh is heir to” was an underestimate and that in reality “the shocks are innumerable” (1962, p. 126).

Recent studies have found that troubles in human life start from the very beginning: the cell-cycle checkpoints (which ensure that cells will not divide until DNA damage is repaired and chromosomal segregation is complete) do not operate properly at the early, cleavage stage in human embryos (Handyside & Delhanty, 1997). This produces mosaicism of the preimplantation embryo, where some embryonic cells are genetically abnormal (McLaren, 1998), with potentially devastating consequences in later life.

Most of the DNA damage caused by copy errors during DNA replication also occurs in early life because most cell divisions happen in early development. As a result of extensive DNA damage in early development, many apparently normal tissues of young organisms have a strikingly high load of mutations, including abundant oncogenic mutations and frequent clones of mutated somatic cells (Cha *et al.*, 1994; Deng *et al.*, 1996;

Jonason *et al.*, 1996; Khrapko *et al.*, 2004; Nekhaeva *et al.*, 2002).

Loss of telomeres, eventually leading to such outcomes as genomic instability, cell death (apoptosis), cell senescence, and perhaps to organism’s aging (Kim *et al.*, 2002), also begins before birth, and it is directly linked to DNA replication during cell divisions, which are particularly intensive at early stages of growth and development (Collins & Mitchell, 2002; DePinho & Wong, 2003; Forsyth *et al.*, 2002; Kim *et al.*, 2002). In humans, the length of telomeres declines precipitously before the age of 4 (by 25 percent) and then declines further very slowly (Hopkin, 2001).

Another potential source of extensive initial damage is the birth process itself. During birth, the future child is first deprived of oxygen by compression of the umbilical cord (Moffett *et al.*, 1993) and suffers severe hypoxia (often with ischemia and asphyxia). Then, just after birth, a newborn child is exposed to oxidative stress because of acute reoxygenation while starting breathing. It is known that acute reoxygenation after hypoxia may produce an extensive oxidative damage through the same mechanisms that also produce ischemia-reperfusion injury (IRI) and asphyxia-reventilation injury (Martin *et al.*, 2000). Asphyxia is a common occurrence in the perinatal period, and asphyxial brain injury is the most common neurologic abnormality in the neonatal period (Dworkin, 1992) that may manifest in neurologic disorders in later life. The brain damage that occurs after asphyxia may cause long-term neurological consequences in full-term infants (Volpe, 2000) and lead to cerebral palsy, epilepsy, and mental retardation (Hack & Fanaroff, 2000; Hjalmarsson *et al.*, 1988, pp. 28–36). Perhaps the rare geniuses are simply those lucky persons whose early-life brain damage was less extensive than the “normal” level. Thus, using Hamlet’s metaphor, we may conclude that humans “suffer the slings and arrows of outrageous

fortune" and have "a sea of troubles" from the very beginning of their lives.

It follows from this concept of HIDL that even small progress in optimizing the processes of ontogenesis and increasing the numbers of initially functional elements can potentially result in a remarkable fall in mortality and a significant improvement in life span. This optimistic prediction is supported by experimental evidence (in laboratory mice) of increased offspring life span if future parents are fed antioxidants, which presumably result in protection of parental germ cells against oxidative damage (Harman & Eddy, 1979).

From this point of view, parental characteristics determining the quality of the gametes, and especially maternal characteristics determining the accuracy of the early stages of development, would be expected to have significant influence on the life span of the offspring, which may be in some cases even stronger than the effect of these same properties of the offspring themselves. In other words, the reliability concept leads us to a paradoxical conjecture: sometimes a better predictor of life span may be found not among the characteristics of the organism itself but among the characteristics of its parents.

Gavrilov & Gavrilova (1991) tested this counterintuitive prediction using data on life span and metabolic characteristics of 21 inbred and F₁-hybrid mouse genotypes (several hundred mice) published by

Sacher & Duffy (1979). It was found that the six traits (body weight and resting and average metabolic rates both at young and old ages) of parental genotypes explained 95 percent of variation in mean life span between 16 F₁-hybrid mice genotypes, whereas the same six traits of hybrid mice themselves explained only 25 percent of variation in their mean life span (Gavrilov & Gavrilova, 1991, pp. 175–182). The highest mean life span was observed in the progeny of those parents who had the lowest resting metabolic rate at young age. This observation is consistent with a hypothesis that the differences in progeny life span could be linked to the rates of oxidative DNA damage in parental germ cells. Interestingly, the resting metabolic rate measured in young progeny itself was not predictive for progeny life span (see Table 1.1).

Thus, certain parameters (such as resting metabolic rate at young age) measured in parents could be better predictors of progeny life span compared to the same parameters measured among the progeny itself.

The concept of high initial damage load also predicts that early-life events may affect survival in later adult life through modulating the level of initial damage. This prediction proved to be correct for such early-life indicators as parental age at a person's conception (Gavrilov & Gavrilova, 1997, 2000, 2003a; Gavrilova *et al.*, 2003) and the month of a person's

Table 1.1
Parental Resting Metabolic Rates at Young Age Are Better Predictors of Life Span of Mice Progeny Than the Resting Metabolic Rates (RMR) Measured in Progeny Itself*

Variable	Regression Coefficient	Standard Error	t-value	p-value
Maternal RMR	-1054	252	-4.18	0.001
Paternal RMR	-795	254	-3.13	0.009
Progeny RMR	42	205	0.20	0.843

*Parameter values for linear regression of progeny life span on parental and progeny resting metabolic rate measured at young age (RMR) for 16 genotypes of F₁-hybrid mice. Computed using data published by Sacher & Duffy (1979).

birth (Doblhammer & Vaupel, 2001; Gavrilov & Gavrilova, 1999, 2003a; Gavrilova *et al.*, 2003). The month of birth may influence a person's life span through early-life exposure to seasonal vitamin deficiencies and seasonal infections during critical periods of child development (Gavrilov & Gavrilova, 2001a). It is known that deficiencies of vitamins B-12, folic acid, B-6, niacin, and vitamins C and E appear to mimic radiation in damaging DNA by causing single- and double-strand breaks, oxidative lesions, or both (Ames, 2004). Vitamin deficiencies had profound seasonality in the past when contemporary adults were born, and these deficiencies may be particularly harmful at the early stages of human development (Gavrilov & Gavrilova, 2001a).

There is mounting evidence now in support of the idea of fetal origins of adult degenerative diseases (Barker, 1998; Kuh & Ben-Shlomo, 1997; Leon *et al.*, 1998; Lucas *et al.*, 1999) and early-life programming of aging and longevity (Gavrilov & Gavrilova, 1991, 2001a, 2003a,b). Women may be particularly sensitive to early-life exposures because they are mosaics of two different cell types (one with active paternal X chromosome and one with active maternal X chromosome), and the pattern of this mosaic is determined early in life. Indeed, this conjecture of stronger female response to early-life exposures is confirmed for such early-life predictors of adult life span as paternal age at a person's conception (Gavrilov & Gavrilova, 1997, 2000, 2003a, 2004a; Gavrilova *et al.*, 2003) and the month of a person's birth (Gavrilov & Gavrilova, 2003a; Gavrilova *et al.*, 2003).

VI. Reliability Models of Aging for Biological Systems

It was demonstrated in Section IV that the aging phenomenon emerges when a system gains some redundancy (reserves).

The failure rate of a simple parallel system built of non-aging elements increases with age, although the initial failure kinetics follows the Weibull law rather than the Gompertz law. This limitation of the model is rooted in the assumption that the system is built of initially ideal structures where all elements are functional from the outset. This standard assumption may be justified for technical devices manufactured from pretested components, but it is not justified for living organisms, presumably replete with defects, for the reasons described earlier. Gavrilov and Gavrilova (1991) proposed a family of reliability models based on the idea of initial damage load, which allows us to explain all three major laws of biological aging and mortality: the Gompertz law, the late-life deceleration law, and the compensation law of mortality (mortality convergence at advanced ages). A brief description of these models is provided below.

A. Highly Redundant System Replete with Defects

The simplest model in this family of reliability models is the model of a series-parallel structure with distributed redundancy *within* the organism (see Gavrilov & Gavrilova, 1991, pp. 252–264; 2001b). If distribution of subsystems within the organism according to initially functional elements can be described by the Poisson law because of high initial damage load, then the failure rate of such series-parallel systems can be approximated initially by the exponential (Gompertz) law with subsequent mortality leveling-off.

According to this model, the compensation law of mortality is inevitable if the "true aging rate" (relative rate of elements' loss) is similar in different populations of a given species (presumably because of homeostasis—stable body temperature, glucose concentration, etc.).

This suggested explanation leads to an interesting testable prediction that for lower organisms with poor homeostasis, there may be deviations from the compensation law of mortality.

B. Partially Damaged Redundant System

The simplest model, which was described earlier, assumed an extremely high level of initial damage load. In a more general model, the distribution of subsystems in the organism according to the number of initially functional elements is described by the binomial rather than Poisson distribution. In this case, the failure rate of a system initially follows the binomial failure law (Gavrilov & Gavrilova, 1991, 2001b).

Thus, if the system is not initially ideal, the failure rate in the initial period of time grows exponentially with age, according to the Gompertz law. A numerical example provided in Figure 1.2 shows that increase in the initial system's damage load (initial virtual age) converts the observed mortality trajectory from the Weibull to the Gompertz one. The model also explains the compensation law of mortality and mortality leveling-off later in life (see Gavrilov & Gavrilova, 1991, 2001b).

Thus, both reliability models described here provide an explanation for a general pattern of aging and mortality in biological species: the exponential growth of failure rate in the initial period, with the subsequent mortality deceleration and leveling-off, as well as the compensation law of mortality.

C. Heterogeneous Population of Redundant Organisms

The models discussed so far examined a situation in which series-connected vital subsystems (blocks) have varying degrees of redundancy *within* each organism, while no additional assumptions were

made about possible initial differences between the organisms themselves. In a more general case, the population heterogeneity needs to be taken into account because there is a large variation in the numbers of cells for the organisms of the same species (Finch & Kirkwood, 2000). The model of heterogeneous redundant systems (Gavrilov & Gavrilova, 1991, pp. 264–272) demonstrates that taking into account the heterogeneity of the population also provides an explanation for all the basic laws of mortality. This model assumes that there is a distribution of organisms with regard to their initial redundancy levels (e.g., number of functional cells) within a population under study. If this distribution is close to either the binomial or the Poisson distribution, then a quasi-exponential (Gompertzian) pattern of mortality increase with age is expected initially, with subsequent mortality leveling-off (Gavrilov & Gavrilova, 1991, pp. 264–272).

Figure 1.9 shows computed data for a model in which organisms have a different number of elements (connected in parallel) and are distributed by their redundancy levels according to the Poisson distribution law, with the mean number of elements equal to λ .

Note that the dependence of the logarithm of failure rate on age is almost a linear one, indicating that the initial failure kinetics is indeed close to the Gompertz law. This initial Gompertzian period of failure rate growth can be easily extended for the organism's entire life span in the case of more complex systems with many vital components (built of parallel elements), each being critical for survival (serial connection of a large number of components; see Section II.D).

Figure 1.9 also demonstrates that the populations of organisms with higher mean levels of redundancy (parameter λ) have lower death rates, but these death rates are growing steeper with age (the compensation law of mortality).

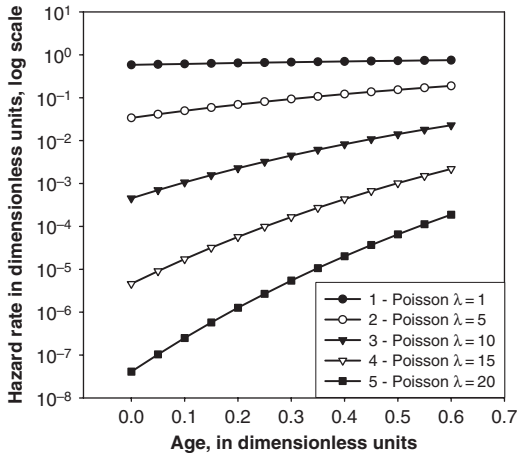

Figure 1.9 Failure kinetics in mixtures of systems with different redundancy levels for the initial age period. The dependence of failure rate as a function of age in mixtures of parallel redundant systems having Poisson distribution by initial numbers of functional elements (mean number of elements, $\lambda = 1, 5, 10, 15, 20$). The scales for mortality rates (vertical axis), and for age (horizontal axis) are presented in dimensionless units (μ/k for mortality rates, and kx for age, to ensure the generalizability of the results (invariance of graphs on failure rate of the elements in the system, parameter k).

D. Accumulation of Defects with Constant Rate of Damage Flow

Another reliability model of aging is obtained after a critical reinterpretation of the assumptions underlying the previously described models. In fact, these models contain an assumption that the death of the organism occurs only when all the elements in a block fail. It is possible that this hypothesis may be justified in a number of cases for some of the organism's subsystems. However, in the majority of cases, the hypothesis seems contentious. For example, it is hard to imagine that a single surviving liver cell (hepatocyte) can assume the functions of an entire destroyed liver. Significantly more realistic is the hypothesis that the system initially contains an enormous number of elements that greatly exceeds the critical number of defects, leading to

the death of the organism. In this case, we arrive at a schema for the accumulation of damage in which the rate of damage flow (equal to the product of the number of elements and their failure rate) turns out to be practically constant in view of the incommensurability of the number of elements and the permitted number of defects (see Gavrilov & Gavrilova, 1991, pp. 272–276).

This model also allows us to take into account the influence of living conditions on the value of the critical number of defects incompatible with the survival of the organism. The key to the solution of this problem is the replacement of the parallel connection hypothesis (assumed in previous models) with the more realistic assumption that there exists a critical number of defects incompatible with the survival of the organism. In this case, it is natural to expect that under harsher conditions, the critical number of defects leading to death might be less than under more comfortable living conditions. In particular, in the wild, when an animal is deprived of care and forced to acquire its own food as well as to defend itself against predators, the first serious damage to the organism can lead to death. It is therefore not surprising that the mortality of many animals (in particular, birds) is practically independent of age in the wild. This follows directly from the single-stage destruction of the organism model. On the other hand, the greater the number of defects the organism can accumulate while remaining alive, the greater its life span will be.

The standard model of defect accumulation with constant rate of damage flow predicts that at the initial moment in time, mortality grows according to a power (Weibull) law of mortality. If we assume that distribution of living organisms according to the number of defects they have is described by the Poisson law, then at the initial moment in time, this model leads to the binomial law of

mortality. In this model, the compensation law of mortality can be obtained both as a result of variation in the degree to which the organisms are initially damaged, and of variation in the critical number of defects, dependent on the harshness of living conditions (see Gavrilov & Gavrilova, 1991, pp. 272–276).

Summarizing this brief review of reliability models, note the striking similarity between the conclusions of the considered models. All these models predict a mortality deceleration, no matter what assumptions are made regarding initial population heterogeneity or its complete initial homogeneity. Moreover, these reliability models of aging produce mortality plateaus as inevitable outcomes for any values of considered parameters. The only constraint is that the elementary steps of the multistage destruction process of a system should occur by chance only, independent of age. The models also predict that an initially homogeneous population will become highly heterogeneous for risk of death over time (acquired heterogeneity). The similarity of conclusions obtained from several different models means that it is impossible on the basis of the established mortality phenomena to uncover the correct mechanism behind the age-related destruction of organisms, and further studies are necessary to discriminate between the competing models.

One can of course derive no pleasure from this circumstance, but there are two reasons that give ground for optimism. First, the different models seem to lead to very similar interpretations of certain mortality phenomena. For example, the compensation law of mortality is only possible when the relative rate of redundancy loss is the same in all populations of a given species. This interpretation of the compensation law of mortality is not only a feature of the models described in this chapter but also of other models (Gavrilov, 1978; Gavrilov

et al., 1978; Strehler & Mildvan, 1960). The existence of a multitude of competing models is therefore compatible with the reliable and meaningful interpretation of a number of mortality phenomena because variability of models does not preclude their agreement on a number of issues. Second, if different models lead to the same formulas—for example the binomial law of mortality—this merely makes the problem of interpreting results more complicated for the theoretician, but significantly facilitates the work for the experimenter. Indeed, for the analysis of data, it is preferable to use a formula that is supported not by a single model but by a whole family of models that encompass a wide spectrum of possible situations.

VII. Evolution of Species Reliability

Reliability theory of aging is perfectly compatible with the idea of biological evolution, and it helps to identify key components that may be important for evolution of species reliability and durability (longevity): initial redundancy levels, initial damage load, rate of redundancy loss, and repair potential. Moreover, reliability theory helps evolutionary theories explain how the age of onset of diseases caused by deleterious mutations could be postponed to later ages (as suggested by the mutation accumulation theory of aging)—this could be easily achieved by a simple increase in the initial redundancy levels (e.g., initial cell numbers).

From the reliability perspective, the increase in initial redundancy levels is the simplest way to improve survival at particularly early reproductive ages (with gains fading at older ages). This exactly matches with the higher fitness priority of early reproductive ages emphasized by evolutionary theories. Evolutionary

and reliability ideas also help to understand why organisms seem to “choose” a simple but short-term solution to the survival problem through enhancing the systems redundancy, rather than a more permanent but complicated solution based on rigorous repair (with a potential for negligible senescence).

It may be interesting and useful to compare failure rates of different biological species expressed in exactly the same units of risk (risk of death per individual per day). Returning back to the earlier Figure 1.4, we can notice with some surprise that the death rates of young vigorous fruit flies kept in protected laboratory conditions is as high as among very old people! This indicates that fruit flies from the very beginning of their lives have very unreliable design compared to humans. This observation also tells us that young organisms of one biological species may have the same failure risk as old organisms of another species—that is, being old for humans is as good as being young for fruit flies. Note that at extreme old ages, the death rates of fruit flies are well beyond human death rates (see Figure 1.4). In terms of reliability models, this observation suggests that fruit flies are made of less reliable components (presumably cells), which have higher failure rates compared to human cells.

We can ask ourselves a question: is it a general rule that shorter-lived biological species should always have higher death rates within comparable age groups (say, within “young” or “old” age groups)? Traditional evolutionary theories suggest that indeed shorter-lived species should have higher “intrinsic” death rates in protected environments because these rates are shaped in evolution through selection pressure by death rates in the wild (predation, starvation, etc.). In other words, defenseless fruit flies in the wild experience much higher death rates than do humans; therefore a selection pressure

to increase their “intrinsic” reliability was less intensive compared to humans. This traditional evolutionary paradigm also says that birds live longer and have lower “intrinsic” death rates because of adaptation to flight, which improved their survival in the wild and increased a selection pressure to further decrease “intrinsic” death rates (Austad, 2001).

Thus, if a bird (say, a finch) is compared to a similar-sized shorter-lived mammal (say, a rat), the expected picture should be similar to Figure 1.4: a bird should have lower death rates than a rat both in the beginning and in the end of their lives. Interestingly, this prediction of traditional evolutionary paradigm could be confronted with an alternative prediction expected from a reliability paradigm. Reliability paradigm predicts that birds should be very prudent in redundancy of their body structures (because it comes with a heavy cost of additional weight, making flight difficult). Therefore, a flight adaptation should force the birds to evolve in a direction of high reliability of their components (cells) with low levels of redundancy (cell numbers). Thus, reliability paradigm predicts that “intrinsic” death rates of birds in protected environments should be rather high at young ages (because of low redundancy levels), whereas at old ages their death rates might be much lower than in other species (because of higher reliability of their cells). This suggestion of higher reliability of avian cells agrees with the recent findings of increased resistance of these cells to oxidative stress and DNA damage (Holmes & Ottinger, 2003; Ogburn *et al.*, 1998, 2001).

Figure 1.10 presents data on “intrinsic” mortality in Bengalese finches as compared to rats for both species living in protected environments.

Note that the death rates in both species are very close to each other at young ages, but later a *mortality divergence* occurs so that old birds have much lower death rates

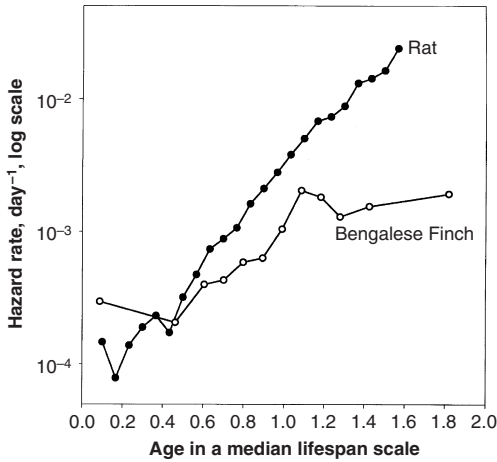

Figure 1.10 Comparative mortality of rats and Bengalese finches expressed in the same units of mortality (per day). Data sources: Bengalese finch, survival data for 39 birds of both sexes in captivity (Eisner, 1967); Rats, survival data for 2,050 female rats kept in a laboratory (Schlettwein-Gsell, 1970).

than old rats. These observations match the predictions of a reliability paradigm but not a traditional evolutionary explanation discussed earlier (the initial death rates for birds are much higher than expected from the traditional evolutionary perspective). Thus, a comparison of species death rates may be useful for testing different ideas on evolution of species aging and reliability.

Another interesting observation comes from a comparison of humans with horses (see Figure 1.11). It could be expected that shorter-lived horses should have higher death rates than humans. However, this prediction is only valid for young ages. The data demonstrate that an old horse is not much different from an old man in terms of mortality risk (see Figure 1.11). This example is opposite to observations on finch–rat comparisons and demonstrates a *mortality convergence* between two different biological species (man and horse) at older ages. In terms of reliability models, this observation may indicate that the rates of the late stages of body destruction are

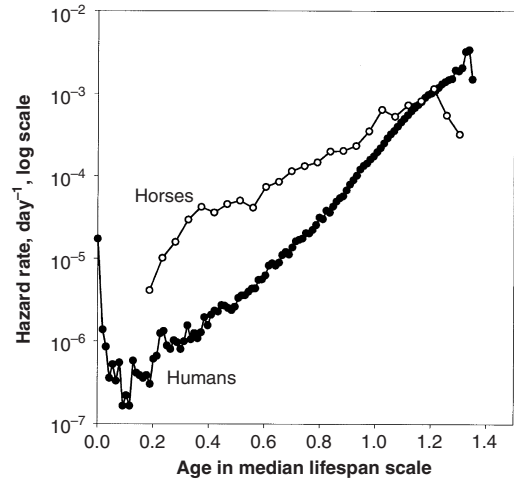

Figure 1.11 Comparative mortality of humans and horses expressed in the same units of mortality (per day). Data sources: Humans, official Swedish female life table for 1985; Horses, survival data for 2,742 thoroughbred mares (Comfort, 1958).

similar in horses and humans, whereas the rates of the early stages of the aging process are vastly different in these two species.

These intriguing findings demonstrate that there are promising opportunities for further comparative studies on the evolution of species reliability and the merging of the reliability and evolutionary theories of aging. This reliability-evolutionary approach could be considered as further development of the earlier comparative studies of species aging and life histories (Austad, 1997, 2001; Gavrilov & Gavrilova, 1991; Holmes *et al.*, 2001; Promislow, 1993, 1994).

Another promising direction for the reliability-evolutionary approach is to study the selection effects for high performance (e.g., the ability to avoid predators). Classic evolutionary theories predict that an exposure to high extrinsic mortality due to predation should produce shorter-lived species (Charlesworth, 2001; Medawar, 1946; Williams, 1957). This prediction could be confronted with the opposite prediction of reliability theory, which says

that elimination of weak individuals by predators should increase species life span because of selection for better performance and lower initial damage load. Interestingly, recent studies found an increased life span of guppies evolving in a high predation environment (Reznick *et al.*, 2004) as predicted by the reliability theory of aging.

VIII. Conclusions

Extensive studies of aging have produced many important and diverse findings, which require a general theoretical framework for them to be organized into a comprehensive body of knowledge.

As demonstrated by the success of evolutionary theories of aging, based on a general idea of the declining force of natural selection with age, quite general theoretical considerations can in fact be very useful and practical when applied to aging research (Charlesworth, 2000; Le Bourg, 2001; Martin, 2002; Partridge & Gems, 2002).

In this chapter, we attempted to go one step further in the search for a broader explanation of aging (not limited to biological species only) by applying a general theory of systems failure known as reliability theory. Considerations of this theory lead to the following conclusions:

1. *Redundancy* is a key notion for understanding aging, and the systemic nature of aging in particular. Systems that are redundant in numbers of irreplaceable elements do deteriorate (i.e., age) over time, even if they are built of non-aging elements. The positive effect of system redundancy is *damage tolerance*, which decreases mortality and increases life span. However, damage tolerance makes it possible for damage to be tolerated and accumulated over time, thus producing the aging phenomenon.

2. An apparent aging rate or expression of aging (measured as age differences in failure rates, including death rates) is higher for systems with higher redundancy levels (all other things being equal). This is an important issue because it helps put a correct perspective over fascinating observations of negligible senescence (no apparent aging) observed in the wild and at extreme old ages. Reliability theory explains that some cases of negligible senescence may have a trivial mechanism (lack of redundancies in the system being exposed to a challenging environment) and, therefore, will not help to uncover “the secrets of negligible senescence.” The studies of negligible senescence make sense, however, when death rates are also demonstrated to be negligible.

Reliability theory also persuades a re-evaluation of the old belief that aging is somehow related to limited economic or evolutionary investments in systems longevity. The theory provides a completely opposite perspective on this issue—aging is a direct consequence of investments into systems reliability and durability through enhanced redundancy. This is a significant statement because it helps us to understand why the expression of aging (differences in failure rates between younger and older age groups) may be actually more profound in more complex redundant systems (organisms) designed for higher reliability.

3. During the life course, organisms are running out of cells (Gosden, 1985; Herndon *et al.*, 2002), losing reserve capacity (Bortz, 2002; Sehl & Yates, 2001), and this *redundancy depletion* explains the observed “compensation law of mortality” (mortality convergence at older ages) as well as the observed late-life mortality deceleration, leveling-off, and mortality plateaus.

4. Living organisms seem to be formed with a high *load of initial damage*, and

therefore their life span and aging patterns may be sensitive to *early-life conditions* that determine this initial damage load during early development. The idea of early-life programming of aging and longevity may have important practical implications for developing early-life interventions promoting health and longevity.

The theory also suggests that aging research should not be limited to studies of qualitative changes (like age changes in gene expression) because changes in *quantity* (numbers of cells and other functional elements) could be an important driving force in the aging process. In other words, aging may be largely driven by a process of redundancy loss.

The reliability theory predicts that a system may deteriorate with age even if it is built from non-aging elements with constant failure rate. The key issue here is the system's redundancy for irreplaceable elements, which is responsible for the aging phenomenon. In other words, each particular step of system destruction/deterioration may seem to be random (no aging, just occasional failure by chance), but if a system failure requires a sequence of several such steps (not just a single step of destruction), then the system as a whole may have an aging behavior.

Why is this important? Because the significance of beneficial health-promoting interventions is often undermined by claims that these interventions are not proven to delay the process of aging itself, but instead that they simply delay or "cover-up" some particular manifestations of aging.

In contrast to these pessimistic views, the reliability theory says that there may be no specific underlying elementary aging process itself; instead, aging may be largely a property of a redundant system as a whole because it has a network of destruction pathways, each being associated with

particular manifestations of aging (types of failure). Therefore, we should not be discouraged by only partial success of each particular intervention, but instead we can appreciate an idea that we do have so many opportunities to oppose aging in numerous different ways.

Thus, the efforts to understand the routes and the early stages of age-related degenerative diseases should not be discarded as irrelevant to understanding "true" biological aging. On the contrary, the attempts to build an intellectual firewall between biogerontological research and clinical medicine are counterproductive. After all, the main reason people are really concerned about aging is because it is related to health deterioration and increased morbidity. The most important pathways of age changes are those that make older people sick and frail (Bortz, 2002).

Reliability theory suggests general answers to both the "why" and the "how" questions about aging. It explains "why" aging occurs by identifying the key determinant of aging behavior: system redundancy in numbers of irreplaceable elements. Reliability theory also explains "how" aging occurs, by focusing on the process of redundancy loss over time as the major mechanism of aging.

Aging is a complex phenomenon (Sehl & Yates, 2001), and a holistic approach using reliability theory may help analyze, understand, and, perhaps, control it. We suggest, therefore, adding reliability theory to the arsenal of methodological approaches applied in aging research.

Acknowledgments

This work was supported in part by grants from the National Institute on Aging.

References

- Ames, B. N. (2004). Supplements and tuning up metabolism. *Journal of Nutrition*, 134, 3164S–3168S.

- Andersen, B. B., Gundersen, H. J., & Pakkenberg, B. (2003). Aging of the human cerebellum: a stereological study. *Journal of Comparative Neurology*, 466, 356–365.
- Andreadis, S., & Palsson, B. O. (1997). Coupled effects of polybrene and calf serum on the efficiency of retroviral transduction and the stability of retroviral vectors. *Human Gene Therapy*, 8, 285–291.
- Austad, S. N. (1997). Comparative aging and life histories in mammals. *Experimental Gerontology*, 32, 23–38.
- Austad, S. N. (2001). Concepts and theories of aging. In E. J. Masoro & S. N. Austad (Eds.), *Handbook of the biology of aging* (5th ed., pp. 3–22). San Diego, CA: Academic Press.
- Ayyub, B. M., & McCuen, R. H. (2003). *Probability, statistics, reliability for engineers and scientists*. Boca Raton, FL: Chapman & Hall/CRC.
- Baizabal, J. M., Furlan-Magaril, M., Santa-Olalla, J., & Covarrubias, L. (2003). Neural stem cells in development and regenerative medicine. *Archives of Medical Research*, 34, 572–588.
- Barker, D. J. P. (1998). *Mothers, babies, and disease in later life* (2nd ed.). London: Churchill Livingstone.
- Barlow, R. E., & Proschan, F. (1975). *Statistical theory of reliability and life testing. Probability models*. New York: Holt, Rinehart and Winston.
- Barlow, R. E., Proschan, F., & Hunter, L. C. (1965). *Mathematical theory of reliability*. New York: Wiley.
- Beard, R. E. (1959). Note on some mathematical mortality models. In G. E. W. Wolstenholme & M. O'Connor (Eds.), *The lifespan of animals* (pp. 302–311). Boston: Little, Brown.
- Beard, R. E. (1971). Some aspects of theories of mortality, cause of death analysis, forecasting and stochastic processes. In W. Brass (Ed.), *Biological aspects of demography* (pp. 57–68). London: Taylor & Francis.
- Bortz, W. M. (2002). A conceptual framework of frailty: a review. *Journal of Gerontology: Medical Sciences*, 57A, M283–M288.
- Brock, T. D., Madigan, M. T., Martinko, J. M., & Parker, J. (1994). *Biology of microorganisms* (7th ed.), Englewood Cliffs, NJ: Prentice-Hall.
- Bronikowski, A. M., Alberts, S. C., Altmann, J., Packer, C., Carey, K. D., & Tatar, M. (2002). The aging baboon: comparative demography in a non-human primate. *Proceedings of the National Academy of Sciences of the USA*, 99, 9591–9595.
- Brooks, A., Lithgow, G. J., & Johnson, T. E. (1994). Mortality rates in a genetically heterogeneous population of *Caenorhabditis elegans*. *Science*, 263, 668–671.
- Burns, J., Clarke, G., & Lumsden, C. J. (2002). Photoreceptor death: spatiotemporal patterns arising from one-hit death kinetics and a diffusible cell death factor. *Bulletin of Mathematical Biology*, 64, 1117–1145.
- Calne, D. B. (1994). Is idiopathic Parkinsonism the consequence of an event or a process? *Neurology*, 44, 5–10.
- Capogrossi, M. C. (2004). Cardiac stem cells fail with aging: a new mechanism for the age-dependent decline in cardiac function. *Circulation Research*, 94, 411–413.
- Carey, J. R., & Liedo, P. (1995). Sex-specific life table aging rates in large medfly cohorts. *Experimental Gerontology*, 30, 315–325.
- Carey, J. R., Liedo, P., Orozco, D., & Vaupel, J. W. (1992) Slowing of mortality rates at older ages in large medfly cohorts. *Science*, 258, 457–461.
- Cargill, Sh. L., Carey, J. R., Muller, H.-G., & Anderson, G. (2003). Age of ovary determines remaining life expectancy in old ovariectomized mice. *Aging Cell*, 2, 185–190.
- Carnes, B. A., Olshansky, S. J., & Grahn, D. (1998). An interspecies prediction of the risk of radiation-induced mortality. *Radiation Research*, 149, 487–492.
- Cha, R. S., Thilly, W. G., & Zarbl, H. (1994). N-nitroso-N-methylurea-induced rat mammary tumors arise from cells with preexisting oncogenic Hras1 gene mutations. *Proceedings of the National Academy of Sciences of the USA*, 91, 3749–3753.
- Charlesworth, B. (2000). Fisher, Medawar, Hamilton and the evolution of aging. *Genetics*, 156, 927–931.
- Charlesworth, B. (2001). Patterns of age-specific means and genetic variances of mortality rates predicted by mutation-accumulation theory of aging. *Journal of Theoretical Biology*, 210, 47–65.

- Choi, J. H., Kim, K. L., Huh, W., Kim, B., Byun, J., Suh, W., Sung, J., Jeon, E. S., Oh, H. Y., & Kim, D. K. (2004). Decreased number and impaired angiogenic function of endothelial progenitor cells in patients with chronic renal failure. *Arteriosclerosis, Thrombosis, and Vascular Biology*, 24, 1246–1252.
- Clark, A. G., & Guadalupe, R. N. (1995). Probing the evolution of senescence in *Drosophila melanogaster* with P-element tagging. *Genetica*, 96, 225–234.
- Clark, V. A. (1975). Survival distribution. *Annual Review of Biophysics and Bioengineering*, 4, 431–448.
- Clarke, G., Collins, R. A., Leavitt, B. R., Andrews, D. F., Hayden, M. R., Lumsden, C. J., & McInnes, R. R. (2000). A one-hit model of cell death in inherited neuronal degenerations. *Nature*, 406, 195–199.
- Clarke, G., Collins, R. A., Leavitt, B. R., Andrews, D. F., Hayden, M. R., Lumsden, C. J., & McInnes, R. R. (2001a). Addendum: a one-hit model of cell death in inherited neuronal degenerations. *Nature*, 409, 542.
- Clarke, G., Lumsden, C. J., & McInnes, R. R. (2001b). Inherited neurodegenerative diseases: the one-hit model of neurodegeneration. *Human Molecular Genetics*, 10, 2269–2275.
- Cohen, H. Y., Miller, C., Bitterman, K. J., Wall, N. R., Hekking, B., Kessler, B., Howitz, K. T., Gorospe, M., de Cabo, R., & Sinclair, D. A. (2004). Calorie restriction promotes mammalian cell survival by inducing the SIRT1 deacetylase. *Science*, 305, 390–392.
- Collins, K., & Mitchell, J. R. (2002). Telomerase in the human organism. *Oncogene*, 21, 564–579.
- Comfort, A. (1958). The longevity and mortality of thoroughbred mares. *Journal of Gerontology*, 13, 342–350.
- Commo, S., Gaillard, O., & Bernard, B. A. (2004). Human hair greying is linked to a specific depletion of hair follicle melanocytes affecting both the bulb and the outer root sheath. *British Journal of Dermatology*, 150, 435–443.
- Crowder, M. J., Kimber, A. C., Smith, R. L., & Sweeting, T. J. (1991). *Statistical analysis of reliability data*. London: Chapman & Hall.
- Curtsinger, J. W., Fukui, H., Townsend, D., & Vaupel, J. W. (1992). Demography of genotypes: failure of the limited life-span paradigm in *Drosophila melanogaster*. *Science*, 258, 461–463.
- Davis, B. D., Dulbeco, R., Eisen, H. N., & Ginsberg, H. S. (1990). *Microbiology* (4th ed.). Philadelphia: Lippincott.
- Deng, G., Lu, Y., Zlotnikov, G., Thor, A. D., & Smith, H. S. (1996). Loss of heterozygosity in normal tissue adjacent to breast carcinomas. *Science*, 274, 2057–2059.
- DePinho, R. A., & Wong, K. K. (2003). The age of cancer: telomeres, checkpoints, and longevity. *Journal of Clinical Investigation*, 111, S9–S14.
- Doblhammer, G., & Vaupel, J. W. (2001). Lifespan depends on month of birth. *Proceedings of the National Academy of Sciences of the USA*, 98, 2934–2939.
- Dobzhansky, T. (1962). *Mankind Evolving. The Evolution of Human Species*. New Haven and London: Yale University Press.
- Dworkin, P. H. (1992). *Pediatrics* (2nd ed.). Malvern, PA: Harwal.
- Eakin, T., Shouman, R., Qi, Y. L., Liu, G. X., & Witten, M. (1995). Estimating parametric survival model parameters in gerontological aging studies. Methodological problems and insights. *Journal of Gerontology: Biological Sciences*, 50A, B166–B176.
- Economos, A. C. (1979). A non-Gompertzian paradigm for mortality kinetics of metazoan animals and failure kinetics of manufactured products. *Age*, 2, 74–76.
- Economos, A. C. (1980). Kinetics of metazoan mortality. *Journal of Social and Biological Structures*, 3, 317–329.
- Economos, A. C. (1983). Rate of aging, rate of dying and the mechanism of mortality. *Archives of Gerontology and Geriatrics*, 1, 3–27.
- Economos, A. C. (1985). Rate of aging, rate of dying and non-Gompertzian mortality—encore . . . *Gerontology*, 31, 106–111.
- Edelberg, J. M., Tang, L., Hattori, K., Lyden, D., & Rafii, S. (2002). Young adult bone marrow-derived endothelial precursor cells restore aging-impaired cardiac angiogenic function. *Circulation Research*, 90, E89–E93.

- Eisner, E. (1967). Actuarial data for the Bengalese finch (*Lonchura striata*: Fam. Estrildidae) in captivity. *Experimental Gerontology*, 2, 187–189.
- Ekerdt, D. J. (Ed.) (2002). *The Macmillan Encyclopedia of Aging*. New York: Macmillan Reference USA.
- Feller, W. (1968). *An introduction to probability theory and its applications*. Vol.1, New York: Wiley.
- Finch, C. E. (1990). *Longevity, senescence and the genome*. Chicago: University of Chicago Press.
- Finch, C. E., & Kirkwood, T. B. L. (2000). *Chance, development, and aging*. New York, Oxford: Oxford University Press.
- Forsyth, N. R., Wright, W. E., & Shay, J. W. (2002). Telomerase and differentiation in multicellular organisms: turn it off, turn it on, and turn it off again. *Differentiation*, 69, 188–197.
- Fukui, H. H., Ackert, L., & Curtsinger, J. W. (1996). Deceleration of age-specific mortality rates in chromosomal homozygotes and heterozygotes of *Drosophila melanogaster*. *Experimental Gerontology*, 31, 517–531.
- Fukui, H. H., Xiu, L., & Curtsinger, J. W. (1993). Slowing of age-specific mortality rates in *Drosophila melanogaster*. *Experimental Gerontology*, 28, 585–599.
- Galambos, J. (1978). *The asymptotic theory of extreme order statistics*. New York: Wiley.
- Gavrilov, L. A. (1978). Mathematical model of aging in animals. *Doklady Akademii Nauk SSSR: Biological Sciences*, 238, 53–55 (English edition).
- Gavrilov, L. A. (1980). *Study of life span genetics using the kinetic analysis*. Ph.D. Thesis, Moscow, Russia: Moscow State University.
- Gavrilov, L. A. (1984). Does a limit of the life span really exist? *Biofizika*, 29, 908–911.
- Gavrilov, L. A., & Gavrilova, N. S. (1979). Determination of species length of life. *Doklady Akademii Nauk SSSR: Biological Sciences*, 246, 905–908 (English edition).
- Gavrilov, L. A., & Gavrilova, N. S. (1991). *The biology of life span: a quantitative approach*. New York: Harwood Academic Publisher.
- Gavrilov, L. A., & Gavrilova, N. S. (1997). Parental age at conception and offspring longevity. *Reviews in Clinical Gerontology*, 7, 5–12.
- Gavrilov, L. A., & Gavrilova, N. S. (1999). Season of birth and human longevity. *Journal of Anti-Aging Medicine*, 2, 365–366.
- Gavrilov, L. A., & Gavrilova, N. S. (2000). Human longevity and parental age at conception. In J.-M. Robine, T. B. L. Kirkwood & M. Allard (Eds.), *Sex and longevity: sexuality, gender, reproduction, parenthood* (pp. 7–31). Berlin, Heidelberg: Springer-Verlag.
- Gavrilov, L. A., & Gavrilova, N. S. (2001a). Epidemiology of human longevity: the search for appropriate methodology. *Journal of Anti-Aging Medicine*, 4, 13–30.
- Gavrilov, L. A., & Gavrilova, N. S. (2001b). The reliability theory of aging and longevity. *Journal of Theoretical Biology*, 213, 527–545.
- Gavrilov, L. A., & Gavrilova, N. S. (2003a). Early-life factors modulating lifespan. In S. I. S. Rattan (Ed.), *Modulating aging and longevity* (pp. 27–50). Dordrecht, The Netherlands: Kluwer Academic Publishers.
- Gavrilov, L. A., & Gavrilova, N. S. (2003b). The quest for a general theory of aging and longevity. *Science of Aging Knowledge Environment [electronic resource]: SAGE KE*, Vol. 2003 Jul 16, 28, RE5. Available at <http://sageke.sciencemag.org>.
- Gavrilov, L. A., & Gavrilova, N. S. (2004a). Early-life programming of aging and longevity: the idea of high initial damage load (the HIDL hypothesis). *Annals of the New York Academy of Sciences*, 1019, 496–501.
- Gavrilov, L. A., & Gavrilova, N. S. (2004b). The reliability-engineering approach to the problem of biological aging. *Annals of the New York Academy of Sciences*, 1019, 509–512.
- Gavrilov, L. A., & Gavrilova, N. S. (2004c). Why we fall apart. Engineering's reliability theory explains human aging. *IEEE Spectrum*, 9, 2–7.
- Gavrilov, L. A., Gavrilova, N. S., & Iaguzhinskii, L. S. (1978). Basic patterns of aging and death in animals from the standpoint of reliability theory. *Journal of General Biology [Zhurnal Obshchei Biologii]*, 39, 734–742.

- Gavrilova, N. S., & Gavrilov, L. A. (2002). Evolution of aging. In D. J. Ekerdt (Ed.), *Encyclopedia of aging* (Vol. 2, pp. 458–467). New York: Macmillan Reference USA.
- Gavrilova, N. S., Gavrilov, L. A., Evdokushkina, G. N., Semyonova, V. G. (2003). Early-life predictors of human longevity: analysis of the 19th century birth cohorts. *Annales de Démographie Historique*, 2, 177–198.
- Gilchrist, B. A., Blog, F. B., & Szabo, G. (1979). Effects of aging and chronic sun exposure on melanocytes in human skin. *Journal of Investigative Dermatology*, 73, 141–143.
- Goldschmidt-Clermont, P. J. (2003). Loss of bone marrow-derived vascular progenitor cells leads to inflammation and atherosclerosis. *American Heart Journal*, 146(4 Suppl), S5–S12.
- Golubev, A. (2004). Does Makeham make sense? *Biogerontology*, 5, 159–167.
- Gompertz, B. (1825). On the nature of the function expressive of the law of human mortality and on a new mode of determining life contingencies. *Philosophical Transactions of the Royal Society of London*, 115A, 513–585.
- Gosden, R. G. (1985). *The biology of menopause: the cause and consequence of ovarian aging*. San Diego: Academic Press.
- Gouda, M. D., Singh, S. A., Rao, A. G., Thakur, M. S., & Karanth, N. G. (2003). Thermal inactivation of glucose oxidase: mechanism and stabilization using additives. *Journal of Biological Chemistry*, 278, 24324–24333.
- Greenwood, M., & Irwin, J. O. (1939). The biostatistics of senility. *Human Biology*, 11, 1–23.
- Gumbel, E. J. (1958). *Statistics of extremes*. New York: Columbia University Press.
- Hack, M., & Fanaroff, A. A. (2000). Outcomes of children of extremely low birthweight and gestational age in the 1990s. *Seminars in Neonatology*, 5, 89–106.
- Hall, J. C. (1969). Age-dependent enzyme changes in *Drosophila melanogaster*. *Experimental Gerontology*, 4, 207–222.
- Handyside, A. H., & Delhanty, J. D. A. (1997). Preimplantation genetic diagnosis: strategies and surprises. *Trends in Genetics*, 13, 270–275.
- Haranghy, L., & Balázs, A. (1980). Regeneration and rejuvenation of invertebrates. In N. W. Shock (Ed.), *Perspectives in experimental gerontology* (pp. 224–233). New York: Arno Press.
- Harman, D., & Eddy, D. E. (1979). Free radical theory of aging: beneficial effects of adding antioxidants to the maternal mouse diet on life span of offspring: possible explanation of the sex difference in longevity. *Age*, 2, 109–122.
- Heintz, N. (2000). One-hit neuronal death. *Nature*, 406, 137–138.
- Herndon, L. A., Schmeissner, P. J., Dudaronek, J. M., Brown, P. A., Listner, K. M., Sakano, Y., Paupard, M. C., Hall, D. H., & Driscoll, M. (2002). Stochastic and genetic factors influence tissue-specific decline in ageing *C. elegans*. *Nature*, 419, 808–814.
- Hirsch, A. G., Williams, R. J., & Mehl, P. (1994). Kinetics of medfly mortality. *Experimental Gerontology*, 29, 197–204.
- Hirsch, H. R., & Peretz, B. (1984). Survival and aging of a small laboratory population of a marine mollusc, *Aplysia californica*. *Mechanisms of Ageing and Development*, 27, 43–62.
- Hjalmarsson, O., Hagberg, B., Hagberg, G., Kubli, F., Patel, N., Schmidt, W., & Linderkamp, O. (Eds.). (1988). *Perinatal events and brain damage in surviving children*. Berlin: Springer-Verlag, pp. 28–36.
- Holmes, D. J., & Ottinger, M. A. (2003). Birds as long-lived animal models for the study of aging. *Experimental Gerontology*, 38, 1365–1375.
- Holmes, D. J., Fluckiger, R., & Austad, S. N. (2001). Comparative biology of aging in birds: an update. *Experimental Gerontology*, 36, 869–883.
- Hopkin, K. (2001). More than a sum our cells. *Science of Aging Knowledge Environment [electronic resource]: SAGE KE*, Vol. 2001 Oct 3, 1, oa4.
- Janse, C., Slob, W., Popelier, C. M., & Vogelaar, J. W. (1988). Survival characteristics of the mollusc *Lymnaea stagnalis* under constant culture conditions: effects of aging and disease. *Mechanisms of Ageing and Development*, 42, 263–174.
- Jay, J. M. (1996). *Modern food microbiology*. New York: Chapman and Hall.

- Johnson, T. E. (1987). Aging can be genetically dissected into component processes using long-lived lines of *Caenorhabditis elegans*. *Proceedings of the National Academy of Sciences of the USA*, 84, 3777–3781.
- Johnson, T. E. (1990). Increased life span of age-1 mutants in *Caenorhabditis elegans* and lower Gompertz rate of aging. *Science*, 249, 908–912.
- Jonason, A. S., Kunalala, S., Price, G. T., Restifo, R. J., Spinelli, H. M., Persing, J. A., Leffell, D. J., Tarone, R. E., & Brash, D. E. (1996). Frequent clones of p53-mutated keratinocytes in normal human skin. *Proceedings of the National Academy of Sciences of the USA*, 93, 14025–14029.
- Keller, G., Zimmer, G., Mall, G., Ritz, E., & Amann, K. (2003). Nephron number in patients with primary hypertension. *New England Journal of Medicine*, 348, 101–108.
- Khazaeli, A. A., Xiu, L., & Curtsinger, J. W. (1996). Effect of density on age-specific mortality in *Drosophila*: a density supplementation experiment. *Genetica*, 98, 21–31.
- Khrapko, K., Ebralidse, K., & Kraytsberg, Y. (2004). Where and when do somatic mtDNA mutations occur? *Annals of the New York Academy of Sciences*, 1019, 240–244.
- Kim, Sh. S. H., Kaminker, P., & Campisi, J. (2002). Telomeres, aging and cancer: in search of a happy ending. *Oncogene*, 21, 503–511.
- Klein, J. P., & Moeschberger, M. L. (1997). *Survival analysis: techniques for censored and truncated data*. New York: Springer-Verlag.
- Kuh, D., & Ben-Shlomo, B. (1997). *A life course approach to chronic disease epidemiology*. Oxford: Oxford University Press.
- Kundi, M. (1999). One-hit models for virus inactivation studies. *Antiviral Research*, 41, 145–152.
- Kunstyr, I., & Leuenberger, H.-G. W. (1975). Gerontological data of C57BL/6J mice. I. Sex differences in survival curves. *Journal of Gerontology*, 30, 157–162.
- Kurganov, B. I. (2002). Kinetics of protein aggregation. Quantitative estimation of the chaperone-like activity in test-systems based on suppression of protein aggregation. *Biochemistry (Moscow)*, 67, 409–422.
- Le Bourg, É. (2001). A mini-review of the evolutionary theories of aging. Is it the time to accept them? *Demographic Research* [electronic resource], 4, 1–28. Available at <http://www.demographic-research.org/volumes/vol4/1/4-1.pdf>.
- Leeuwenburgh, C. (2003). Role of apoptosis in sarcopenia. *Journal of Gerontology: Biological Sciences*, 58A, B999–B1001.
- Leon, D. A., Lithell, H. O., Vågerö, D., Koupilová, I., Mohsen, R., Berglund, L., Lithell, U.-B., & McKeigue, P. M. (1998). Reduced fetal growth rate and increased risk of death from ischaemic heart disease: cohort study of 15,000 Swedish men and women born 1915–29. *British Medical Journal*, 317, 241–245.
- Libby, P. (2003). Bone marrow: a fountain of vascular youth? *Circulation*, 108, 378–379.
- Lindop, P. J. (1961). Growth rate, lifespan and causes of death in SAS/4 mice. *Gerontologia*, 5, 193–208.
- Lucas, A., Fewtrell, M. S., & Cole, T. J. (1999). Fetal origins of adult disease: the hypothesis revisited. *British Medical Journal*, 319, 245–249.
- Makeham, W. M. (1860). On the law of mortality and the construction of annuity tables. *Journal of the Institute of Actuaries*, 8, 301–310.
- Martin, G. M. (2002). Gene action in the aging brain: an evolutionary biological perspective. *Neurobiology of Aging*, 23, 647–654.
- Martin, L. J., Brambrink, A. M., Price, A. C., Kaiser, A., Agnew, D. M., Ichord, R. N., & Traystman, R. J. (2000). Neuronal death in newborn striatum after hypoxia-ischemia is necrosis and evolves with oxidative stress. *Neurobiology of Disease*, 7, 169–191.
- Martinez, D. E. (1998). Mortality patterns suggest lack of senescence in hydra. *Experimental Gerontology*, 33, 217–225.
- Masoro, E. J. (2003). Subfield history: caloric restriction, slowing aging, and extending life. *Science of aging knowledge environment* [electronic resource]: SAGE KE, Vol. 2003 Feb 26, 8, RE2.
- Masoro, E. J. (2005). Are age-associated diseases an integral part of aging? In E. J. Masoro & S. N. Austad (Eds.), *Handbook of the biology of aging* (6th ed.). San Diego, CA: Academic Press.

- Massoff, R. W., Dagnelie, G., Beneschawel, T., Palmer, R. W., & Finkelstein, D. (1990). First order dynamics of visual field loss in retinitis pigmentosa. *Clinical Vision Sciences*, 5, 1–26.
- McKiernan, S. H., Bua, E., McGorray, J., & Aiken, J. (2004). Early-onset calorie restriction conserves fiber number in aging rat skeletal muscle. *The FASEB Journal*, 18, 580–581.
- McLaren, A. (1998). Genetics and human reproduction. *Trends in Genetics*, 14, 427–431.
- Medawar, P. B. (1946). Old age and natural death. *Modern Quarterly*, 2, 30–49. [Reprinted in Medawar, P.B. (1958). *The uniqueness of the individual* (pp. 17–43), New York: Basic Books].
- Moffett, D. F., Moffett, S. B., & Schauf, C. L. (1993). *Human physiology: foundations and frontiers* (2nd ed.). St. Louis: Mosby.
- Nekhaeva, E., Bodyak, N. D., Kravtsov, Y., McGrath, S. B., Van Orsouw, N. J., Pluzhnikov, A., Wei, J. Y., Vijg, J., & Khrapko, K. (2002). Clonally expanded mtDNA point mutations are abundant in individual cells of human tissues. *Proceedings of the National Academy of Sciences of the USA*, 99, 5521–5526.
- Nyengaard, J. R., & Bendtsen, T. F. (1992). Glomerular number and size in relation to age, kidney weight, and body surface in normal man. *Anatomical Record*, 232, 194–201.
- Ogburn, C. E., Austad, S. N., Holmes, D. J., Kiklevich, J. V., Gollahon, K., Rabinovitch, P. S., & Martin, G. M. (1998). Cultured renal epithelial cells from birds and mice: enhanced resistance of avian cells to oxidative stress and DNA damage. *Journal of Gerontology: Biological Sciences*, 53A, B287–B292.
- Ogburn, C. E., Carlberg, K., Ottinger, M. A., Holmes, D. J., Martin, G. M., & Austad, S. N. (2001). Exceptional cellular resistance to oxidative damage in long-lived birds requires active gene expression. *Journal of Gerontology: Biological Sciences*, 56A, B468–B474.
- Olshansky, S. J. (1998). On the biodemography of aging: a review essay. *Population and Development Review*, 24, 381–393.
- Olshansky, S. J., & Carnes, B. A. (1997). Ever since Gompertz. *Demography*, 34, 1–15.
- Partridge, L., & Gems, D. (2002). The evolution of longevity. *Current Biology*, 12, R544–R546.
- Partridge, L., & Mangel, M. (1999). Messages from mortality: the evolution of death rates in the old. *Trends in Ecology and Evolution*, 14, 438–442.
- Pearl, R., & Miner, J. R. (1935). Experimental studies on the duration of life. XIY. The comparative mortality of certain lower organisms. *Quarterly Review of Biology*, 10, 60–79.
- Peleg, M., Normand, M. D., & Campanella, O. H. (2003). Estimating microbial inactivation parameters from survival curves obtained under varying conditions—the linear case. *Bulletin of Mathematical Biology*, 65, 219–234.
- Perks, W. (1932). On some experiments in the graduation of mortality statistics. *Journal of the Institute of Actuaries*, 63, 12–57.
- Promislow, D. E. (1993). On size and survival: progress and pitfalls in the allometry of life span. *Journal of Gerontology: Biological Sciences*, 48, B115–B123.
- Promislow, D. E. (1994). DNA repair and the evolution of longevity: a critical analysis. *Journal of Theoretical Biology*, 170, 291–300.
- Rausand, M., & Høyland, A. (2003). *System reliability theory: models, statistical methods, and applications* (2nd ed.). Hoboken, NJ: Wiley-Interscience.
- Rauscher, F. M., Goldschmidt-Clermont, P. J., Davis, B. H., Wang, T., Gregg, D., Ramaswami, P., Pippen, A. M., Annex, B. H., Dong, C., & Taylor, D. A. (2003). Aging, progenitor cell exhaustion, and atherosclerosis. *Circulation*, 108, 457–463.
- Reznick, D. N., Bryant, M. J., Roff, D., Ghalambor, C. K., & Ghalambor, D. E. (2004). Effect of extrinsic mortality on the evolution of senescence in guppies. *Nature*, 431, 1095–1099.
- Ricklefs, R. E., & Scheuerlein, A. (2002). Biological implications of the Weibull and Gompertz models of aging. *Journal of Gerontology*, 57A, B69–B76.
- Rigdon, S. E., & Basu, A. P. (2000). *Statistical methods for the reliability of repairable systems*. New York: Wiley.

- Rockstein, M., & Lieberman, H. M. (1959). A life table for the common house fly, *Musca domestica*. *Gerontologia*, 3: 23–36.
- Sacher, G. A. (1966). The Gompertz transformation in the study of the injury-mortality relationship: application to late radiation effects and ageing. In P. J. Lindop & G. A. Sacher (Eds.), *Radiation and ageing* (pp. 411–441). London: Taylor and Francis.
- Sacher, G. A. (1977). Life table modification and life prolongation. In C. E. Finch & L. Hayflick (Eds.), *Handbook of the biology of aging* (pp. 582–638). New York: Van Nostrand Reinhold.
- Sacher, G. A., & Duffy, P. H. (1979). Genetic relation of life span to metabolic rate for inbred mouse strains and their hybrids. *Federation Proceedings*, 38, 184–188.
- Schlettwein-Gsell, D. (1970). Survival curves of an old age rat colony. *Gerontologia*, 16, 111–115.
- Schulzer, M., Lee, C. S., Mak, E. K., Vingerhoets, F. J. G., & Calne, D. B. (1994). A mathematical model of pathogenesis in idiopathic Parkinsonism. *Brain*, 117, 509–516.
- Shel, M. E., & Yates, F. E. (2001). Kinetics of human aging: I. Rates of senescence between ages 30 and 70 years in healthy people. *Journal of Gerontology: Biological Sciences*, 56A, B198–B208.
- Strasser, H., Tiefenthaler, M., Steinlechner, M., Eder, I., Bartsch, G., & Konwalinka, G. (2000). Age dependent apoptosis and loss of rhabdosphincter cells. *Journal of Urology*, 164, 1781–1785.
- Strehler, B. L. (1978). *Time, cells, and aging* (2nd ed.). New York and London: Academic Press.
- Strehler, B. L., & Mildvan, A. S. (1960). General theory of mortality and aging. *Science*, 132, 14–21.
- Tatar, M., Carey, J. R., & Vaupel, J. W. (1993). Long-term cost of reproduction with and without accelerated senescence in *Callosobruchus maculatus*: analysis of age-specific mortality. *Evolution*, 47, 1302–1312.
- United Nations (1967). *Demographic Yearbook, 1966*, 18th issue. New York: United Nations.
- United Nations (1975). *Demographic Yearbook, 1974*, 26th issue. New York: United Nations.
- Vanfleteren, J. R., De Vreese, A., & Braeckman, B. P. (1998). Two-parameter logistic and Weibull equations provide better fits to survival data from isogenic populations of *Caenorhabditis elegans* in axenic culture than does the Gompertz model. *Journal of Gerontology: Biological Sciences*, 53A, B393–B403.
- Van Zant, G., & Liang, Y. (2003). The role of stem cells in aging. *Experimental Hematology*, 31, 659–672.
- Vaupel, J. W., Carey, J. R., Christensen, K., Johnson, T., Yashin, A. I., Holm, N. V., Iachine, I. A., Kannisto, V., Khazaeli, A. A., Liedo, P., Longo, V. D., Zeng, Y., Manton, K., & Curtsinger, J. W. (1998). Biodemographic trajectories of longevity. *Science*, 280, 855–860.
- Volpe, J. (2000). *Neurology of the newborn* (4th ed.). Philadelphia: Saunders.
- Wallace, W. H., & Kelsey, T. W. (2004). Ovarian reserve and reproductive age may be determined from measurement of ovarian volume by transvaginal sonography. *Human Reproduction*, 19, 1612–1617.
- Weibull, W. A. (1939). A statistical theory of the strength of materials. *Ingeniorsvetenskapsakademiens Handlingar*, 151, 5–45.
- Weibull, W. A. (1951). A statistical distribution function of wide applicability. *Journal of Applied Mechanics*, 18, 293–297.
- Williams, G. C. (1957). Pleiotropy, natural selection and the evolution of senescence. *Evolution*, 11, 398–411.
- Wilmoth, J. R. (1997). In search of limits. In K. W. Wachter & C. E. Finch (Eds.), *Between Zeus and the salmon. The biodemography of longevity* (pp. 38–64). Washington, DC: National Academy Press.